

MARCH  
19

# PROTECT BY-PASS CONDENSERS

See page 3

# RADIO WORLD

REG. U.S. PAT. OFF.

An Intimate Visit  
To Roxy's Studio

America's First and Only National Radio Weekly

HOW  
TO READ  
DIAGRAMS

*Air Clear  
Soon, Asserts  
Hoover*

*Bias on  
RF Improves  
Selectivity*

WIRING  
NEW 4-TUBE  
UNIVERSAL

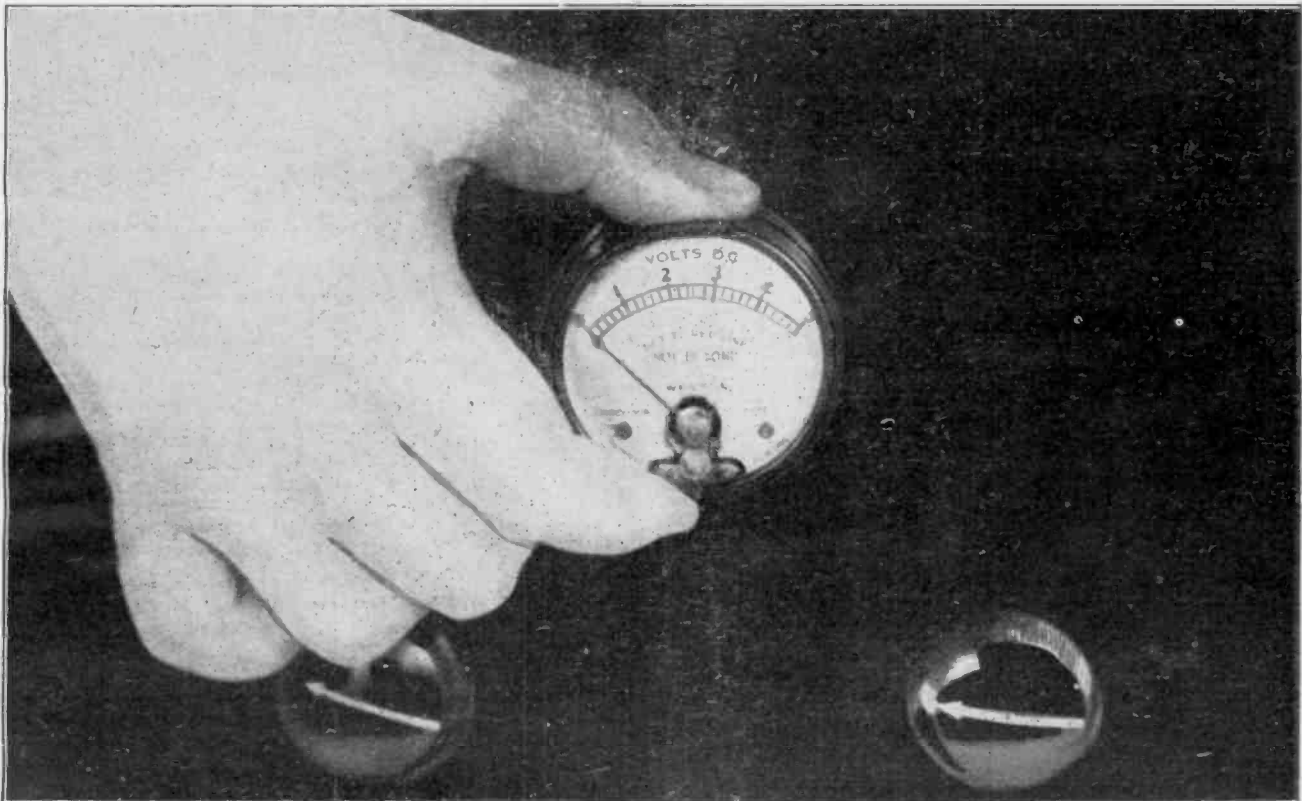

(Hayden)

A PIN-JACK VOLTMETER may be removed from the front panel for use in measuring voltages at other points. See page 5.

QUESTIONS ANSWERED

Three  
Full Pages

15  
CENTS

# THE "R" IS MADE STRAIGHT LINE!

**I**N electricity in all its forms, including radio, "R" stands for resistance. Any resistor that is variable should vary directly in proportion to the adjustment. In variable grid leaks this asset of "straight line R" has been missing. But now it is supplied—efficiently, perfectly—in

## The New De Luxe Model **BRETWOOD** Variable Grid Leak

The improvements made in the new model—imported from England and released for the first time—are:

(1) Constant readings, (2) even distribution of the resistance element, (3) support provided for optional base-board mountings.

By using the Bretwood Variable Grid Leak you improve tone quality, by avoiding detector tube overloading, achieved by correct leak setting. Thereafter the leak may be varied for extremely distant stations, or may be left at the original setting.

North American Bretwood Co., 145 West 45th St., N. Y. City.

Gentlemen: Enclosed find \$1.75. Send me at once one De Luxe Model Bretwood Variable Grid Leak on 5-day money-back guarantee. (Or \$2.25 for leak with grid condenser attached.)

NAME .....  
ADDRESS .....  
CITY..... STATE.....

*Inquiries Solicited from the Trade*

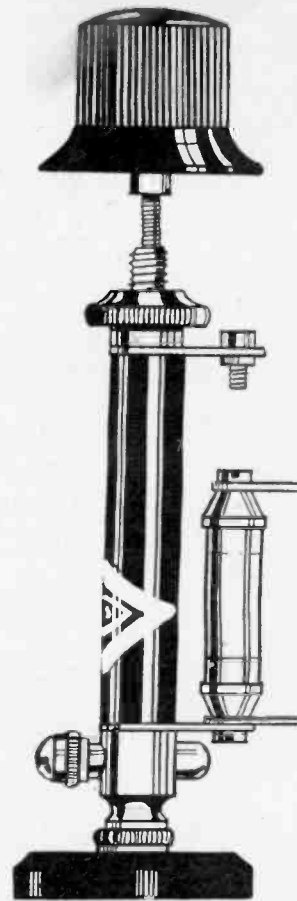

The DE LUXE MODEL with Condenser Attached

*The De Luxe Model Bretwood Variable Grid Leak specified by Herman Bernard for Radio World's Four-Tube Universal Receiver.*

1. The knob is hard rubber.
2. The shaft is durable brass, and can not jam or stick.
3. The brass lock nut, with milled edge, enables single hole panel mount.
4. The barrel is of hard rubber and houses the the resistnace element and plunger.
5. The lugs are adjustable to any position within the sweep of a circle.
6. The grid condenser is securely fastened to the lower lug and requires no extra room, as it is within the projection of the lugs.
7. The syphon container distributes a constant supply of resistance element, making the reading straight line resistance, and preventing uneven distribution of the resistance element.
8. The hard rubber pedestal affords the option of perpendicular mounting, as on a base-board.

Each Bretwood Variable Grid Leak and Bretwood Bullet Condenser is guaranteed against mechanical or electrical imperfections and is sold on an absolute five-day money-back guarantee.

If you're not delighted with results, then we're not even satisfied!

## Filter Condensers Spared From Breakdown Due to Voltage Surges

### Sudden Voltage Rise Causes Puncture Due to Overstrain

By J. E. Anderson

Consulting Engineer

A GREAT deal of trouble has been encountered in the breaking down of filter condensers in B battery eliminators. It is only natural that the manufacturers of condensers should be blamed for this, but in fairness to them it must be said that they are not responsible. Most of the manufacturers of condensers test their products on a voltage, both flash and working, which is many times that of the rated voltage, and the rated voltage is much higher than that which is used in modern amplifiers, even when power tubes are employed. For example, a condenser may be rated at 500 volts on steady voltage and this condenser is recommended in circuits in which the voltage does not exceed 250 volts. Yet when a condenser of this rating is put in a circuit in which the voltage does not exceed even 220 the condenser will frequently puncture, due to overstrain.

The cause of the trouble lies in surges in the B elimination circuit, the peak voltage of which in exceptional cases may exceed 10,000 volts. No condenser made for B eliminator purposes could stand such voltage for an instant, and it would not be practical to make condensers which would stand it.

Since voltage surges of high peak value are like to occur under certain conditions, it is of importance to take precautions to prevent them. It is much easier to prevent surges and thus protect the condensers than to replace the condensers. In order to take appropriate precautionary measures it is necessary to know just what causes surges.

#### What Causes Surges

Surges are caused by discharges of electric energy stored in an inductance coil or a condenser, and the violence of the surge depends on the amount of energy thus stored and on the resistance in the circuit in which the surge takes place. The lower the resistance is the more violent is the surge.

The energy stored in an inductance coil is equal to one-half of the product of the inductance in henrys and the square of the current flowing in the coil at the time that the surge starts. In symbols this may be stated  $E = \frac{1}{2} LI^2$ , where E is the energy, L the inductance and I is the current. The strength of the surge from a coil is therefore proportional to the inductance of the coil and to the square of the current flowing in it. The energy stored in a condenser which is charged to a voltage V is equal to one-half the product of the square of the voltage multiplied by the capacity of the condenser. Stated in symbols this is  $E = \frac{1}{2} CV^2$ . Therefore the strength of a surge from this source is proportional to the capacity of the condenser and to the square of the voltage to which it is charged.

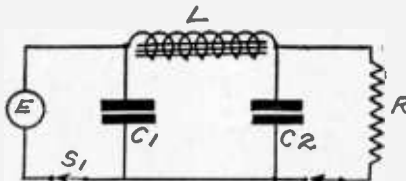

IN THE familiar filter circuit shown above, E is the voltage source, S1 is a switch, C1 and C2 are filter condensers, L is the choke coil and R represents the resistance.

#### Circuit Considered

Consider a circuit comprising an inductance of large value and a resistance of fairly high value. Suppose that the coil be suddenly short-circuited. The resistance in the short circuit is then only the resistance of the coil itself, and this may be comparatively low. The energy in the coil stored in the form of magnetism is suddenly discharged. A momentary current of very high value flows but the current dies down with extreme rapidity. The voltage across the coil at any instant is proportional to the rapidity with which the current changes, and this voltage may rise to very high values just as the short-circuit occurs. Very often it is enough to break down the insulation of the coil turns. This frequently happens to audio frequency transformers which are short-circuited by with a jack and plug. When the coil is short-circuited with a large condenser instead of with a short piece of conductor virtually the same thing happens. The condenser simply becomes a part of the insulation between the two ends of the coil, but the short circuit caused by a condenser may be much more complete than that caused with a short piece of wire, and consequently the strain on the insulation will be greater.

The lower resistance of the coil is, the more violent will be the surge when the field of the coil collapses. The peak of the highest voltage surge could readily be calculated if the inductance of the coil, the resistance in series with it, and the capacity of the condenser were known.

#### Two in Series

When there are two condensers in series across an inductance coil, the total voltage across the coil is divided between the condensers proportional to their impedances, or inversely proportional to their capacities. In case of breakdown it is always the smaller one which gives way first, or this may be the only one that is punctured.

There is a complication when there is a condenser connected across a coil which makes puncture more certain, and that is resonance. If the resistance in the circuit is low enough the discharge will be oscillatory. This usually will increase the intensity of the surge peaks and it will also lengthen the time of its duration. In any coil that is satisfactory for filtering, the resistance is low enough to admit an oscillatory discharge. But whether the discharge is oscillatory or not, the break, if at all, will occur the instant the short-circuit is made. The only practical way of preventing

### Gradual Discharge of Coil or Condenser Is Called the Only Remedy

surges to discharge the coil or condenser gradually. This does not mean that it is necessary to do it in a long space of time. If the discharge takes place in from a tenth of a second to one second the condensers will be accurately protected.

How may gradual discharge be affected? By gradually inserting a resistance into the circuit to decrease the direct current flowing in the coil from normal value to zero. The current should not be stopped suddenly by opening a switch in the main line, as is often done manually or automatically.

One of the simplest ways of introducing a resistance gradually into the eliminator circuit is to open the filament circuit of the set first. The plate current, and therefore the direct current in the inductance coils in the filter, flows because of filament emission. If the filament switch is turned first the tube cools gradually and the emission decreases very slowly. When the filament is cold the emission is zero and therefore the resistance in series with the coils is infinite. Thus the coils and condensers are not subjected to any surges.

The current may also be decreased gradually by turning off the power on the line. The rectifier tube will then cease to function gradually and the direct current in the filter coils will decrease very slowly until no current flows. It does not matter much whether a non-filament or filament type of rectifier is used. The power in the supply line, of course, may be turned off suddenly by any ordinary switch.

#### The Switches

If there are switches in the filter circuit as at S1 and S2, Fig. 1, or in similar positions on the other side of line, they should not be opened first under any circumstances. Dangerous surges are very likely to take place. The least penalty for doing so is the cost of a new filter condenser. A surge of violent nature is set up in the circuit LC1C2 when the direct current in the line is interrupted, and this surge endangers the weakest or the smallest condenser in series with the coil.

When the current is decreased gradually by first turning off the filament current, the greatest voltage across any of the condensers across the line is the output voltage of the rectifier, and this can never exceed the peak voltage across the secondary of the transformer that feeds the rectifier. Hence if the condensers used may be safely operated on this voltage they will be safe in the filter circuit. The voltage across the secondary is often 440 volts, which is equivalent to a peak voltage of 622 volts. This is considerably higher than the steady voltage across the filter condensers will ever be, and therefore if the condensers are rated at 1,000 volts, or even at 500 volts, the condensers will be safe as long as there are no surges.

# Grid Bias for Selectivity

## How Negative Voltage Reduces Interference

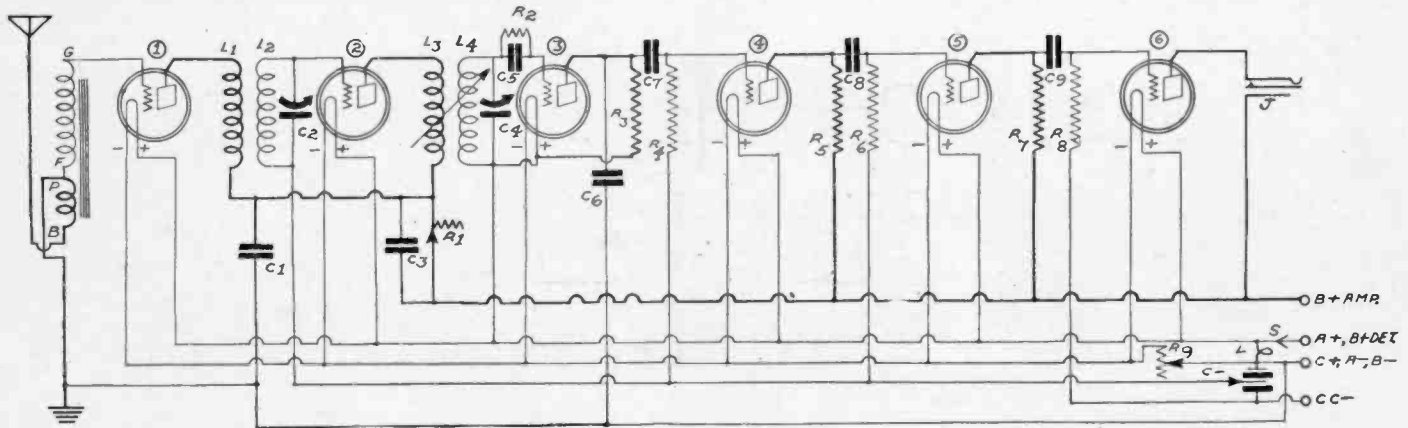

THE GRID of the first tube is returned to minus A in the above circuit, as it is merely a pickup stage, with little amplification, but the second RF tube is negatively biased for increased selectivity.

WITH selectivity the outstanding consideration of the moment, because stations are so numerous and close together in frequency, much attention has been given to circuit designs that will afford high selectivity. Yet little attention has been paid publicly to the proper use of radio frequency amplifying tubes so that their contribution to selectivity may be adequately capitalized. The characteristics of such tubes, as well as those of special detector tubes, are such that improper use may impair selectivity.

Selectivity is something most usually associated with receiver circuits, coils and condensers, but the tube is entitled to a just share of the honors.

### Meaning of Selectivity

Selectivity may be regarded as the ability of an operating receiver to restrict reception to only one frequency, or to a very narrow band of desired frequencies, at a time. As the problem arises usually in connection with wavelengths or frequencies quite close together, selectivity enables discrimination among these wavelengths or frequencies, the acceptance of one of them to the exclusion of all others. Thus is inter-station interference avoided. That goal is very important today.

A circuit is selective because its resistance to a desired wavelength is very low when the correct dial settings prevail, while the resistance to other wavelengths at those same settings is very high.

Now, to make things easy for the desired signal while maintaining barriers against all other frequencies, you may introduce a negative grid bias on the radio-frequency amplifying tubes if the usual 67½ to 90 volts are applied to the plates of those tubes. Absence of such bias is equivalent to putting a resistance across the coil or variable condenser in the tuned circuit.

### Called "Input Impedance"

The technical term used to describe

such a condition in the tuned circuit is that when the tube is used without bias the "input impedance" is low.

The negative grid bias, besides reducing the plate current drain on the B supply, whether that supply be batteries or eliminator, increases the input impedance, resulting in decreased damping of the input circuit (grid to filament).

A low input impedance, therefore, is equivalent to adding a resistance in parallel with the tuning condenser, thus broadening the tuning and reducing the voltage built up across the condenser by a given signal voltage. This effect may be reduced to a minimum by the negative grid bias. Even so small a bias as one volt helps considerably in improving selectivity, although reducing the plate current only slightly.

### Current Drain

For instance, the CX-301A, a popular radio frequency amplifying tube (which is also a good detector and audio amplifier), draws 6 milliamperes of plate current at 90 volts with the grid connected to the negative filament; i. e., at zero grid bias. If the grid is negatively biased only one volt, as by connecting the grid return to the battery side of the rheostat (to minus A), instead of to minus filament, the plate current is reduced to 5 milliamperes. This is due to the one volt negative grid bias resulting from the drop of one volt in the rheostat. But at 4.5 volts negative grid bias, again assuming the same plate voltage of 90, the plate current drops to 2 milliamperes, a reduction of 66½ per cent.

However, for radio frequency amplifying purposes some may prefer to use less than 4.5 volts negative bias, the maximum negative grid bias recommended for a plate voltage of 90, because of the somewhat lessened volume resulting from negatively biasing the radio frequency amplifying tubes to the allowable limit.

On the score of selectivity the gain even from a single volt of negative grid

bias is relatively much larger than the saving in plate current drain, because the increased input impedance is pronounced.

### Sensitive Detector

An indirect relationship between the tube and selectivity exists in regard to the CX-300A, the special detector that outperforms its predecessors without being critical as to filament or plate voltage. This tube, which works on the alkali vapor principle, is something new in tube design. Its recommended operating voltages are 5 volts filament and 45 volts on the plate. Preferably the grid should be returned to negative filament. This tube greatly increases the volume of weak signals, for instance when distant stations are being received, as compared with the results obtained when using a CX-301A as detector. On strong signals the ear does not notice this particular effect so readily.

Hence, if one desires greater selectivity it is possible to sacrifice the volume gain to accomplish the possibly more important end. Looser coupling of the antenna may be employed. One popular method is to place a fixed condenser, say of .0001 mfd. capacity or smaller, in series with the aerial. Another is to remove turns from the coil that is in the aerial circuit.

### How to Connect

The series connection of the fixed condenser consists of joining one side to the antenna binding post of the receiver, and the other side of the fixed condenser to the antenna lead-in wire that has been removed from the antenna post of the set. The reduction of the number of turns on the antenna coil is a substitute for the series condenser remedy, and is not auxiliary.

The use of loose coupling reduces the detrimental effect of the antenna resistance, hence increases selectivity. Less energy is induced, and volume is comparatively less, where one compares results, using a given type of detector tube.

## Government Wins War Tube Litigation

The United States Government has won, in the final court, its long legal fight with the De Forest Radio Telephone & Telegraph Co. over radio tubes manufactured by the Government for its own use in the World War. The suit, in which the

De Forest Co., as plaintiff, charged patent infringement, was decided finally by the United States Supreme Court. Chief Justice Taft wrote the opinion, affirming the judgment rendered by the Court of Claims. The gravamen of the opinion by Chief

Justice Taft, his associates concurring, was that the De Forest Co., by implied consent, had licensed the Government under the tube patent. (This patent has since expired.)

The plaintiff's plea to collect damages was rejected.



# Versatility for Voltmeter

## Pin Jack Type May Be Used When Off Panel

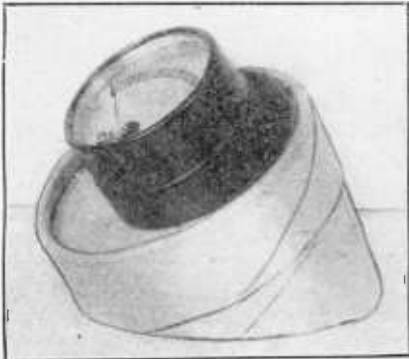

HOW THE pin-jack voltmeter appears in the cardboard container.

By Herbert E. Hayden

Photos by the Author

THE cardboard container in which ice cream, milk, soda, etc., is brought home, may be used very successfully to mount a pin jack voltmeter to test external voltages.

About three inches from the bottom of the container draw a line around the entire circumference. Saw off with a hack saw. Now from either point on the cut off portion draw a line to about one inch from the opposite edge. This is done with the aid of a piece of cord which has been tightly tied around the tubing in this

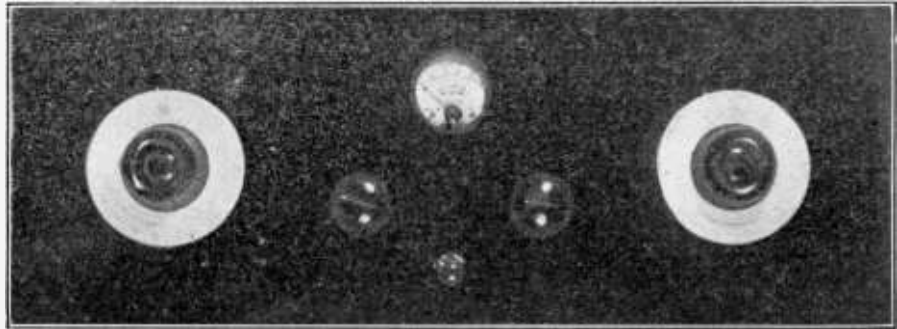

How the pin-jack voltmeter appears on the front panel of a receiver.

fashion. Now saw off the portion. Now place the form with the diagonal side up. The closed end of the tubing should now face you. Now procure the voltmeter and center off the holes to be punched or drilled. Two phone tip jacks should now be obtained. The holes for mounting these should be punched or drilled through. The jacks are then inserted in these holes.

A piece of cardboard, Bakelite, hard rubber or wood may be fitted into the bottom of the tubing. Long leads (about eight feet) should be brought through holes drilled near the bottom on any point of the circumference. Eyelets should be placed through these holes to

prevent the cardboard from tearing, by the constant pulling of the leads.

The leads are then brought to the jacks. The device is then ready for operation. Insert the voltmeter in the jacks and place the leads across the terminal of any battery. Note which is the positive or negative lead. Now get some gummed paper. Cut off two pieces about one inch long and wide enough to fit around the entire surface of the wire. Mark these pieces of paper plus and minus. Fit the proper plus and minus papers over the leads you have found to require them.

This device should prove very useful to the trouble shooter and installation man.

Other Photo on Front Cover

## How I Made My "Fenway" Work Better

By Dana Adams

While the results obtained with the Fenway as originally designed are extremely good, as many satisfied builders will testify, two faults in the radio stage are apparent to those operating the receiver. First, the necessity of tapping the coupler for shorter wave bands and the use of loading coils for the higher waves; secondly, continuous oscillation is encountered below 250 meters, or if this is stopped, the higher waves are extremely handicapped. After many trials with a number of these receivers, I evolved the stage described herewith, which eliminated these difficulties.

As shown in the diagram, a Silver Marshall coil is used in place of the coupler. The losses of taps and loading coils are thus eliminated. The 110 type coil for the wave band desired is plugged in giving a sharp tuned circuit over the entire range.

A variable high resistance is put in series with the B battery feed of the radio stage. This raises and lowers the voltage on this tube under the control of the operator. As lower waves are tuned in the B voltage is lowered to counteract the natural increase in the feed back. On the higher waves the tube efficiency is increased by raising the voltage, thus keeping the tube at the peak at all times.

### Simple Adjustment

The adjustment necessary to obtain these

results is simple. Merely turn the rotor coil of the Silver Marshall until the oscillation point is reached on the highest wave of the band. Of course, full voltage is applied to the tube on this adjustment. It will then be found that the Royalty stops oscillation at all points on the band.

The changes necessary in the receiver are also an easy matter. The coupler and its shielding are removed from the set. The Type J Royalty is mounted in the hole occupied formerly by the coupler shaft. The tube socket, grid condenser, and leak in the middle can be moved as far to the right as possible. This makes room for the coil base which is mounted on the left. The wiring changes are evident from the diagram and need no explanation. The .1 condenser may be mounted on the outside of the can and one side soldered to ground.

### Condenser Connection

The by-pass condenser on the second detector plate should be .005 and is connected

to the plate and filament minus. This change, while seemingly independent of the radio stage, is necessary as on the four tube side this condenser is disconnected if connection is made to A plus. If regeneration is not obtained on the high waves with 67 volts on the plate, raise the voltage on the 67 volt post to 90 volts. A readjustment of the Royalty on the sub panel will then be necessary to give proper voltage on the intermediate amplifier tubes.

While reams have been written on quality, a few words on this subject concerning the Fenway are not amiss. The true worth of the larger power tubes cannot be emphasized too strongly. Particularly in the case of a receiver as powerful as the Fenway. A UX 171, an output transformer, and the proper B and C batteries make a far greater amount of the reserve power of this receiver available, with truly wonderful quality.

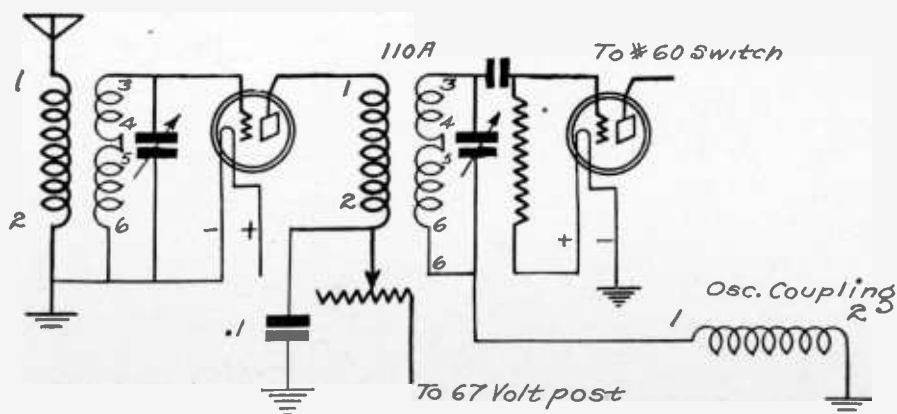

THE REVISED RF stage in the Fenway.

# Psycho-Analyzing Circuits

## How to Sort Out "the Big Idea" Quickly

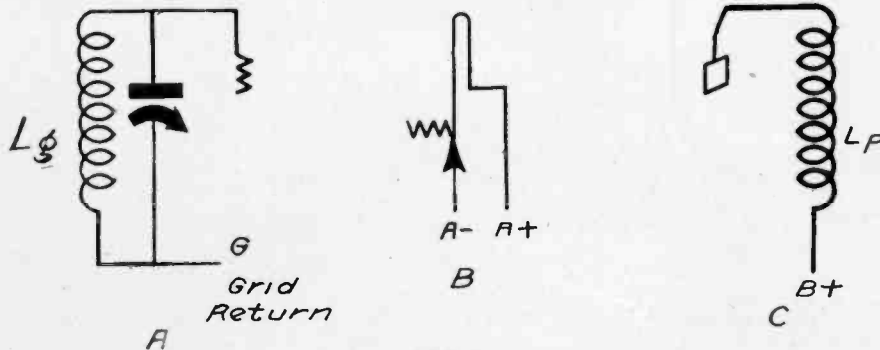

FIG. 1

A shows the fundamental of the grid circuit, B the filament circuit and C the plate circuit.

By Thomas L. McKay

McKay Instrument Co.

ARE you continually trying to figure out the diagrams of new sets? Can you tell, at a glance, what the designer of a particular circuit is attempting to do?

If you are a real fan the first question answers itself. The second question is also easy to answer as far as the average man is concerned. The answer to this question usually being, no!

It is not surprising that many persons have trouble in understanding radio circuit diagrams. Radio is still a new field and the subject is more technical than the average man's education has provided for. The reading of circuit diagrams, however, is very simple if the principles underlying these diagrams are understood.

There is one fundamental circuit from which any type of circuit may be built up. There are no exceptions to this where standard types are considered. Anything, from a 1-tube regenerator to a 12-tube Super-Heterodyne, is included.

### Fundamental Grid Circuit

In Fig. 1, A shows the fundamental of the grid circuit. The grid combination shown, representing the grid circuit of a tuned radio frequency or detector stage, is basically the same as that needed for an audio stage. If this were an audio stage, the condenser C would be dispensed with and the inductance  $L_g$  would now be the secondary of an audio transformer or a coupling unit such as is used in resistance and impedance amplifiers.

Considering A as a radio frequency amplifier, it might be used in an untuned stage in which case the condenser C would be dispensed with. It could then be used as an intermediate amplifier in a super-Heterodyne, providing the inductance of  $L_g$  be changed. In a tuned stage the condenser C could be left out and the coil  $L_g$  split, one section being rotary with respect to the other. This system is often used and is known as inductive tuning. We may thus change the grid circuit to meet our various needs and still have the same fundamental idea of an inductance and capacity to handle the frequency being used. The idea may seem far-fetched in its audio application but here it is still a case of providing the proper frequency paths.

### Filament Resistors

Fig. 1B shows the second unit to consider, namely, the filament circuit. The filament system, roughly speaking, may be handled independently of the grid and plate circuits. The filament is used to cause the tube electron emission and to act as a return for the grid circuit.

Standard practice is to wire the tube filaments in parallel, using some means of controlling the amount of current being fed into any particular tube. This may be accomplished by the use of some sort of ballast, such as an Amperite, or by variable resistors, such as a rheostat. Sometimes a pressure higher than the standard six volts is to be used. In this event the tube filaments may be connected in series, each tube thus causing enough pressure drop so that the combination of tubes used will take care of the applied pressure.

Fig. 1C shows the plate circuit of a tube. The inductance  $L_p$  may be the primary of an audio transformer or may be the choke used in impedance coupling. Again, it might be a resistor as is used in resistance coupling. We still have a path circuit provided to take care of the current flow. In radio frequency stages  $L_p$  is often made rotary with respect to the secondary coil, with which it couples. Such a system is employed in the Karas Equamatic.

In modern practice the audio stage design is rather well standardized. In a new design of radio circuit one may usually substitute any type of audio stages and still retain the features of the particular circuit.

### Principally RF Changes

The changes in modern circuits are principally in the design of the radio frequency and detector stages. The questions here arise: Why are the radio frequency units of some sets designed differently than those in other sets? What problems arise in circuit design to make changes necessary in the achieving of certain results?

The answer to the above questions lies in the fact that radio frequency stages tend to oscillate and this oscillation must be damped or choked, if the set is to operate properly. Maximum efficiency, in a radio stage, is obtained just below the point where the stage oscillates. Thus the circuit should be damped just enough to prevent oscillation but not enough to make the set dead or non-sensitive to weak signals.

A, in Fig. 2, shows a combination of a coil and condenser. For each setting of C, this combination has one frequency to which it will respond. If L picks up a 300 meter wave we know that LC is in resonance or in tune with any 300 meter or 1,000,000 cycles per second vibration.

B, in Fig. 2, represents two wires such as are used on pianos. Suppose both x and y are the same size, same length, and are stretched to the same tension. Suppose x, when plucked, vibrates at the rate of 256 vibrations per second. This is then a measure of the frequency of this string just the same as the LC combination of A has a given period for a given setting of C. Now, if x be plucked, it will vibrate and y will

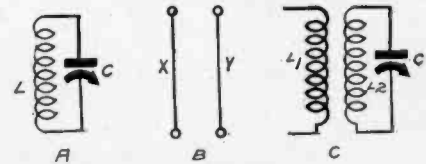

FIG. 2

A is a tuned circuit, B is a representation of two strings, X and Y, and C is a capacity tuned mutually inductive circuit.

also start vibrating, if x and y be close enough together. This is due to the fact that x and y are in resonance or respond to the same frequency of vibration.

### String Oscillation

Suppose, in C of Fig. 2, we have a high frequency current flowing through  $L_1$ . The combination of  $L_2C$  will have the same frequency of current flowing also if C be adjusted as to throw  $L_2C$  in resonance with the frequency of the current in  $L_1$ . This is just the same as the case of the two strings in B, the strings being used to help get the idea resonance.

We know that the plucked string x oscillates but we also know that, if enough mechanical resistance be applied to x, it will cease vibrating. The same is true in the LC combination of A. Adding electrical resistance to this circuit will damp the oscillation.

A, in Fig. 3, denotes an ordinary radio frequency stage. There is a condenser or capacity effect between the grid and plate elements of the tube. This is shown by the dotted lines. It is the combination of this condenser plus the inductances  $L_g$  and  $L_p$  that forms the troublesome oscillating circuit in a radio frequency tube. B, in Fig. 3 shows this circuit better, the other units of the regular circuit being left out for the sake of simplicity.

### Two Oscillation Controls

There are two basic methods of halting the oscillation of the circuit of B, Fig. 3. The first of these is by putting electrical resistance in the line, as was suggested before. The second method is by applying a reverse pressure or potential to one side of the condenser made up of the grid and plate elements of the tube. This reversely directed pressure must be just great enough to counteract the pressure acting to cause the tube to oscillate.

A simple example of the principle just mentioned follows: Suppose a man were pushing a car along the road. If another man stepped in front of the car and started holding it back, the car would stop moving. The car would stand still just so long as both men pushed with the same force. If one or the other shoved harder than his competitor the car would move in the direction this man was pushing.

Coming back to our circuit, we have the same condition. There is a certain force (electrical pressure) tending to make the circuit oscillate. If a force (electrical pressure) of the same magnitude but oppositely directed be applied to the circuit, the pressure tending to make the set oscillate will be equalized and the combination will remain stable. If too much back pressure be applied the combination will again start, just as in the case of the car.

It is the application of the two above-mentioned principles of oscillation control that is responsible for most of the changes in the various types of radio frequency stages now being designed.

Examples of the use of resistance, to damp oscillation, are found in sets using

fixed or variable resistors in the grid return of each radio frequency stage. Potentiometers are also often employed. A radio frequency choke may be used as in the Equamatic circuit. This resistance may as well be placed in the plate circuit of the tube to be controlled. This is often done. Enough resistance is obtained by winding the radio stage coils with a small gauge wire, and this method is sometimes applied. The important thing to remember is that if enough resistance be inserted anywhere in the circuit of B, Fig. 3, the stage will not oscillate.

**Resistance Examples**

The best examples of the feedback pressure system are found in the Hazeltine neutralizing system and those of Rice and Roberts. All of these systems are basically the same.

If every circuit be read with the idea of not tracing every wire but rather, with the idea of catching the outstanding features, it will not be long until one becomes a rapid reader of these diagrams. The important points to note when reading a diagram follow:

- 1 The filament system is usually of minor importance and any system of control preferred may be used just so long as it is correct.
- 2 The audio system is usually a standard system of coupling and any system may be substituted. In special cases where the whole idea of the circuit design lies in the audio end, it is necessary to notice what is done here.

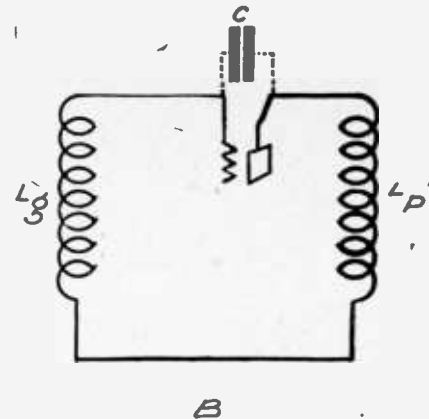
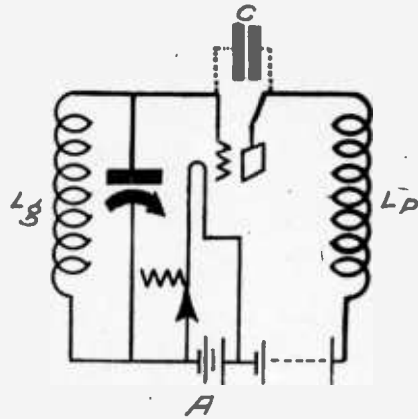

FIG. 3

The inter-electrode tube capacity is shown in dotted lines at A and B.

3 The radio frequency stages must be observed closely, attention being centered around the grid and plate lines. The important things to note are: the type of plate and grid coils employed and their constants, the type of stage tuning being employed, which one of the two basic methods of damping oscillation is being used, and how this oscillation control is constructed and operated (so many neutralizers are good theoretically but are hard to handle practically).

4 The detector circuit should be studied to see what system, if any, is used to

gain regeneration. The method of controlling this regeneration should be noticed. Another method of applying regeneration may often be substituted.

Circuits are flexible in design. One outstanding feature of one circuit may be combined with a feature of another designer. A circuit that fits one set of conditions may not be suitable for another case. Through practice in reading diagrams it is possible to note the feature points of every circuit. The knowledge thus gained is often helpful in repairing or reconstructing a set. It is rather satisfying to be able to glance at a diagram and "tell the boys all about it."

# Reception Now Satisfies Even Musical Experts

## Improved Audio Amplification Elevates Radio to First-Class Performance—Donle's Truphonic Coupler Cited as an Example

By John F. Rider

The cause of the objections voiced by musicians against radio as a medium of musical entertainment has been removed. Simultaneously, with the same stroke, the goal of engineers interested in the development of audio frequency amplification has been attained.

This step was accomplished by one who has made many noteworthy contributions to the science of radio transmission and reception—H. P. Donle, the eminent physicist and engineer. His patents cover such well-known items as the Alkaline vapor tube, better known as the Sodian tube; the spider-web coil, and many gas content tubes used in radio. The audio frequency achievement is the development of a new system of such amplification known as Truphonic, utilizing new electrical principles of operation. The electrical phenomena utilized for the energy transfer between the circuits in this system is not to be found in existing systems and is the development of the inventor.

**Timbre Kept Constant**

The greatest objection voiced by musicians against radio as a medium of conveying music has been that the reproduction was not natural; that is, it was either low pitched or high pitched. Furthermore, that the relationship in amplitude of the fundamental and harmonic frequencies when reproduced was not the same as that of the signal when transmitted into the microphone. A variance in this relationship changes the timbre of the sound, and a soprano sounds like a contralto and a violin like a 'cello.

They also claimed that due consideration was not accorded by the receiver engineers to the electrical laws and physical laws pertaining to the conversion of sound into electrical energy, and the reception of this electrical energy and its reconversion back into sound. Musicians agreed that when these laws are given consideration and the proper relationship maintained between the fundamental and the overtone frequencies, the reproduction in the home of the fan will be natural.

**Impartial Amplification**

This new system fulfills the requirements and consequently nullifies the objections. The frequency range of the Truphonic coupling units is from 37 to 10,000 cycles, with a practically flat curve between 80 and 10,000 cycles. This means that the amplitude relationships between the frequencies of a complex wave within this band will be retained without any accentuation or attenuation. In other words, if a soprano sang a 1,200 cycle note, which contained for the sake of argument the third, fifth and seventh harmonics with amplitude relationship of respectively 30%, 5% and 2% of the fundamental, they would be amplified uniformly and the amplitude of the fundamental and the harmonics would vary in the same proportion. This would make possible natural reproduction. If the fifth and seventh harmonics were attenuated, the timbre of this soprano's voice would be altered, and the reproduction would not be natural.

Another salient feature of this new system is the minimization of phase angle distortion in the coupling unit and tube combinations. This form of distortion is very

seldom considered in the design of the average audio frequency amplifier, and is extensively present in many cases.

**How System Works**

The operating principle of this new system of audio frequency amplification is the attainment of energy transfer through a medium of balanced electro-magnetic coupling and capacitive coupling, a system dissimilar to existing systems of audio frequency amplification. The system is non-oscillating, and adaptable to average conditions without necessitating any special equipment. The standard tubes used for audio amplification are satisfactory.

The design of the units comprising an individual coupling unit differ as much physically from conventional audio frequency coupling units as does the principle of operation from any conventional system. The balance between the electro-magnetic coupling and the capacitive coupling is automatic within each unit, as to frequency and the amount of power passed into the system.

## WRNY Makes a Bid For Short Wave, Too

Preparations are under way, and application for a short wavelength has been made, to put WRNY on the air with two wavelengths, one its normal wavelength, the second, a short one below 50 Meters. The directors of the station believe in the tremendous carrying power of short waves. The short wave set will be hooked up to WRNY's Coytesville transmitter, where the two waves will be put on the air simultaneously, both carrying the same program at all times. The exact wavelength will be announced shortly.

**HARMONICA POPULARIZED**

Radio has been partly responsible for great increases in the popularity of the harmonica, an old instrument which has become the father of a large and varied family. Today, harmonica bands are often heard over the air, and when proper harmonica arrangements are used, the effect of the music is distinctly pleasing.

# Wiring the New Universal

## Explained from Aerial to Speaker Posts

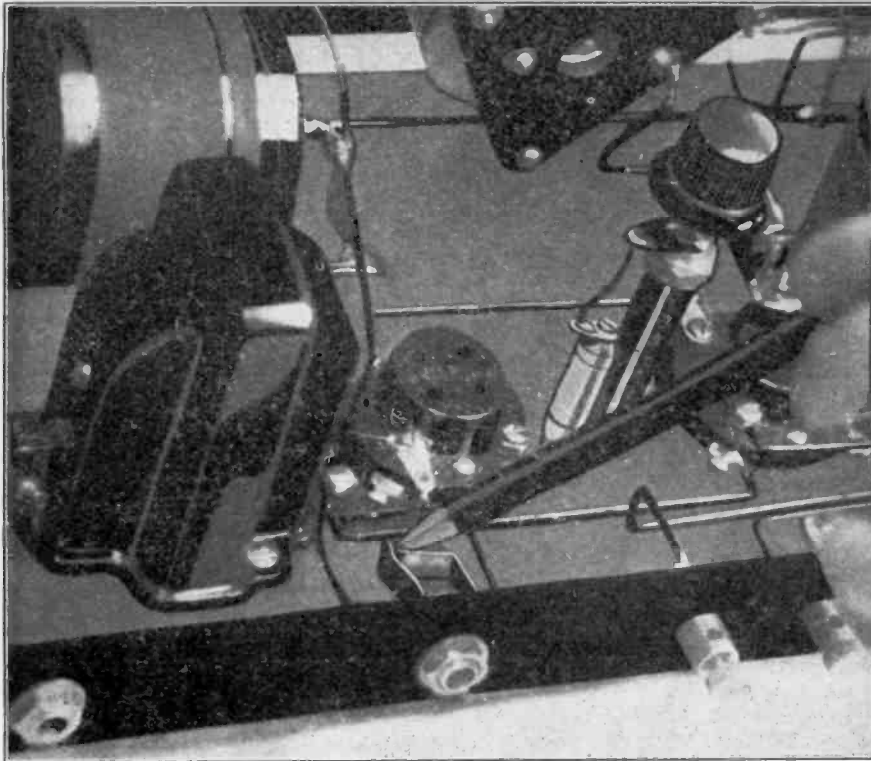

FIG. 3

The Jack J1 into which a phonograph pickup may be plugged is located on the  $10\frac{1}{2}$  x  $1\frac{1}{2}$  inch strip at rear of the baseboard.

By *Herman Bernard*

Associate Institute of Radio Engineers

### PART II.

THE first instalment of this two-part article, on how to build the new Universal 4-tube receiver, in last week's issue, ended with a discussion of how to mount the dials. A few more remarks on this point will prove helpful.

Put the dial on the condenser shaft. Have the plates of the condenser all in. Set the dial at 100. Place the dial up against the panel, gently pressing on the exact middle of the dial knob. Press until you can feel a little springy effect of the friction disc.

The pressure should be so that the friction disc is in contact with the panel, but not enough pressure should be given to force the bakelite edge of the dial against the panel. There should be a separation between the panel and the bakelite edge of the dial.

When the dial is in proper position tighten the screw *tightly*. If the dial has not been pushed up against the panel sufficiently for the disc to have a slight pressure on the panel the dial will not operate.

### Constructional Work

As for the constructional details and wiring, the panel may be considered first. This is 7 by 21 inches. It may be mounted perpendicular to the baseboard or sloping. The laboratory model was of the sloping variety, and for that reason the Benjamin adjustable subpanel brackets were used. The slope was 2 inches, so that the completed receiver would fit into a Corbett model TS cabinet. The bottom of the baseboard itself was not secured directly to the brackets but each bracket was screwed to a piece of wood  $\frac{3}{4}$  inch wide by 5 inches long by half an inch thick. If screws are long enough, i. e., about  $\frac{3}{4}$  inch used, then the same screws may be inserted into the bottom of

the brackets through the elevating studs to the wooden baseboard. The baseboard may be 20 by  $7\frac{1}{2}$  inches.

For example, the part of the baseboard nearest the front panel should be  $1\frac{1}{4}$  inches from the back of the front panel.

The dials are located on a central panel line, i. e., with shafts  $3\frac{1}{2}$  inches from top and bottom. The left-hand dial is centered six inches from the left and the right-hand dial an equal distance from the right. The rheostat is on the same center line,  $2\frac{1}{2}$  inches from the left, while the switch is on the same plane,  $2\frac{1}{2}$  inches from the right.

The regeneration condenser, C5, is on the same center line,  $10\frac{1}{2}$  inches from the left or right, while the pilot light is also on the  $10\frac{1}{2}$  perpendicular line, with center  $1\frac{1}{2}$  inches from top. The dial pointers of the particular model used (Eureka) are on the same perpendicular line as the center

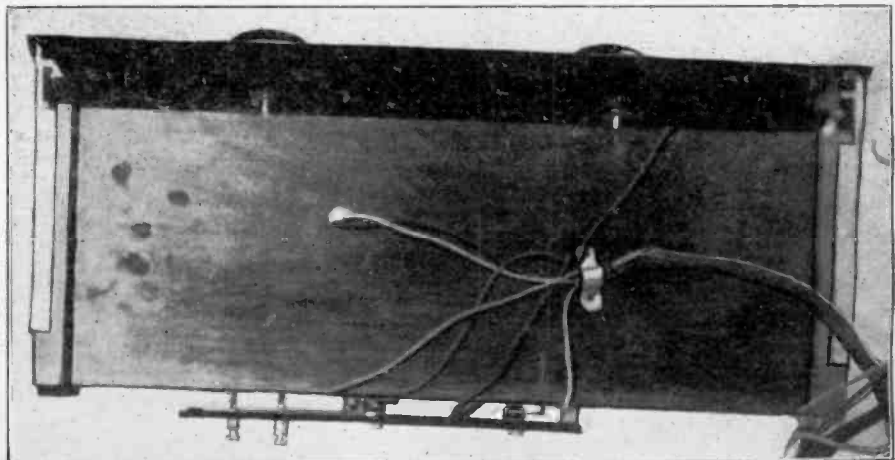

FIG. 4

The cable is run underneath the baseboard and is protected against strain by screwing down a flexible metal bracket. To give the cable headway two elevating wooden strips are screwed under the baseboard, at left and right.

### LIST OF PARTS

L1L2, L3L4—Two General Radio 200-600 meter coupling coils, type 277-D.

C1 C2—Two General Radio .0005 mfd. variable condensers, type 247-F.

R5, C3—One Bretwood de luxe variable grid leak with .00025 mfd. grid condenser attached.

C4—One General Radio 50 mmfd, micro-condenser, type 368-B.

C5—One General Radio 12 mmfd, micro-condenser, type 368-A.

J1—One Electrad single circuit closing jack.

J2—One Electrad single open circuit jack.

R1, R4—Two 112 Amperites, with mountings.

R3—One 1A Amperite, with mounting.

R2—One General Radio 6-ohm rheostat, type 301.

S1—One Yaxley battery switch, No. 20 (window and pilot light, P, optional.)

AF1—One General Radio audio transformer, 1 to 2.7 ratio, type 285-D.

AF2—One General Radio audio transformer, 1 to 2 ratio, type 285-L.

1, 2, 3 and 4—Four General Radio sockets, type 349.

Two Karas Micrometric dials.

Two Eureka dial pointers.

One 7x21-inch Lignole front panel.

One  $8\frac{1}{2}$ x20-inch baseboard.

One pair of Benjamin adjustable sub-panel brackets.

One 6-lead Birnbach cable.

Two binding posts, Ant. and Gnd.

One metal strip for securing cable to baseboard.

One hard rubber or Bakelite strip,  $10\frac{1}{2}$ x  $1\frac{1}{2}$  inches.

Two angle brackets to mount strip.

### ACCESSORIES

Three Eveready 45-volt standard heavy-duty Layerbilt B batteries, No. 486.

Two Eveready  $4\frac{1}{2}$ -volt C batteries.

One 7x21-inch Corbett sloping cabinet.

Two CX-301A tubes for sockets 1 and 3, one CX-300A for socket 2 and 1CX-112 for socket 4.

One Octacone loudspeaker.

shaft, with  $\frac{3}{16}$  holes  $\frac{1}{2}$  inch up from the periphery of the dial.

### Coil Mounting

The coils are mounted so that the antenna coupler is perpendicular and the interstage coupler horizontal. The primary of the antenna coupler is nearer the baseboard. The center of the antenna coupler



form is  $1\frac{3}{4}$  inches from the left if a 20 inch baseboard is used, and is three inches from the front of a  $7\frac{1}{2}$  inch deep baseboard. The interstage coupler is modeled with primary to the left as you face the front panel and with the coil form at the left,  $9\frac{1}{2}$  inches from the left-hand end of the baseboard and with the center two inches back.

The sockets are all on the same left and right line, which is  $2\frac{1}{2}$  inches from the back of the baseboard, measuring from the center of each socket. From left to right these centers of the sockets are in inches: Socket 1,  $4\frac{1}{2}$ ; Socket 2,  $3\frac{3}{4}$ ; Socket 3,  $5\frac{1}{2}$ ; Socket 4,  $5\frac{1}{4}$ .

The De Luxe Model Bretwood Variable Grid Leak is mounted between sockets 1 and 2. A pedestal is provided with each leak for such mounting.

**Leak Setting**

The leak setting need not be changed if the most sensitive position is obtained. This setting depends upon two factors, in particular, one of them, the plate voltage and the plate current, and the other, the filament emission. As the grid return of the detector is to F minus, the grid return consideration is removed from the biasing calculation. Good reception will be obtained on almost any setting of the leak. However, when tuning in a distant station or any other weak signal, adjust the leak until signals are loudest, and thereafter leave the leak in that position unless you replace the detector tube, when it may be necessary to make an individual adjustment in the same manner.

The balancing condenser is mounted with the screw holes  $1\frac{1}{8}$  inches from the rear of the baseboard and respectively,  $\frac{3}{8}$  and  $1\frac{1}{8}$  inches from the left. The strip at the rear of the baseboard has each part (from the left to right), as follows: Ant. and Gnd. binding posts, the audio input jack, J1, and output jack, J2. The strip brackets are  $4\frac{1}{4}$  and  $13\frac{3}{4}$  inches from the left.

The Amperites from left to right have their center holes 4 inches to the left of the baseboard,  $12\frac{1}{2}$  inches from left and  $2\frac{1}{2}$  inches from right, all of them  $2\frac{1}{2}$  inches back from the front of the  $7\frac{1}{2}$  inch deep baseboard. If these points are calculated from the front panel add  $1\frac{5}{8}$  inches to the measurements previously given for measuring from the front of the baseboard, as the baseboard of the laboratory model was that far from the front panel rear.

**Strip Holes**

The antenna post is  $1\frac{1}{2}$  inches from the left on the strip, ground post  $2\frac{3}{4}$  inches, input jack, 5 inches, and the output jack,  $8\frac{1}{2}$  inches. The mounting holes for the strip may be  $\frac{3}{8}$  of an inch from the left and right of the strip.

The first audio transformer, AFT1, is placed between sockets 2 and 3, with the P and B posts to left, and the other audio transformer between sockets 3 and 4, with P and B posts to left. The hole drilled in the bottom of the baseboard for bringing the cable leads through is 8 inches from the left and  $2\frac{1}{2}$  inches back from the baseboard front.

Four holes for the Benjamin brackets will be on the front panel and four on the baseboard. For those who desire to follow the laboratory model the holes are  $9/16$  from the left to right respectively, there being two holes at each side, one on top of the other. The elevations are  $\frac{5}{8}$  from the bottom and  $1\frac{7}{8}$  from the bottom.

It may be advisable to insert four screws, two in each side of the baseboard, and run them through from the top of the baseboard to the supporting shelving on the baseboard, even though the screws used on the inside penetrate the baseboard through the supporting shelving. (Concluded on page 28)

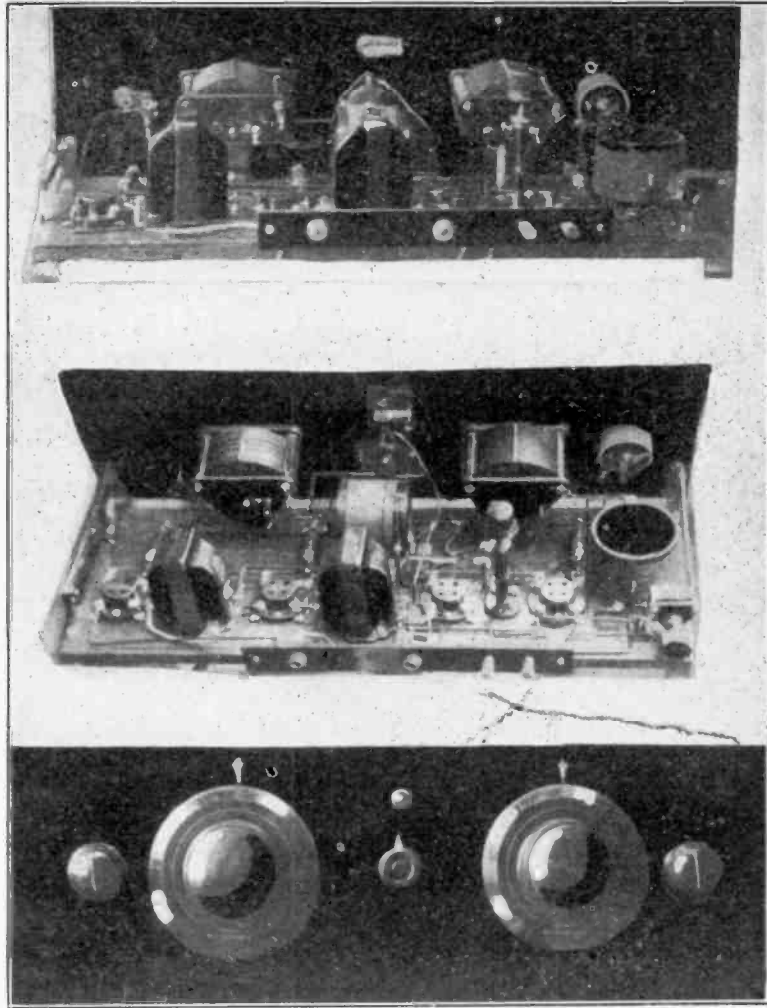

FIGS. 5, 6 AND 7  
The rear, top and panel views of the new Universal receiver.

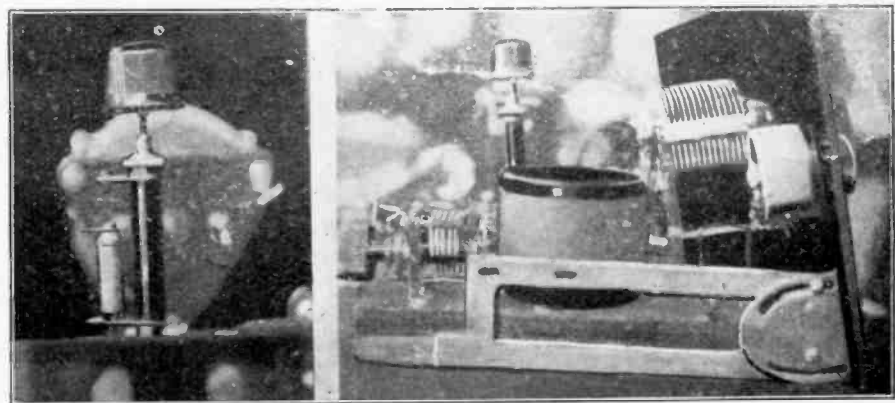

FIGS. 8 AND 9  
The lower end of the secondary L4 goes to the lower end of the grid condenser C3, shown at left mounted on the Bretwood variable grid leak. At right is an end view, showing the extra strip of wood used for elevating the baseboard.

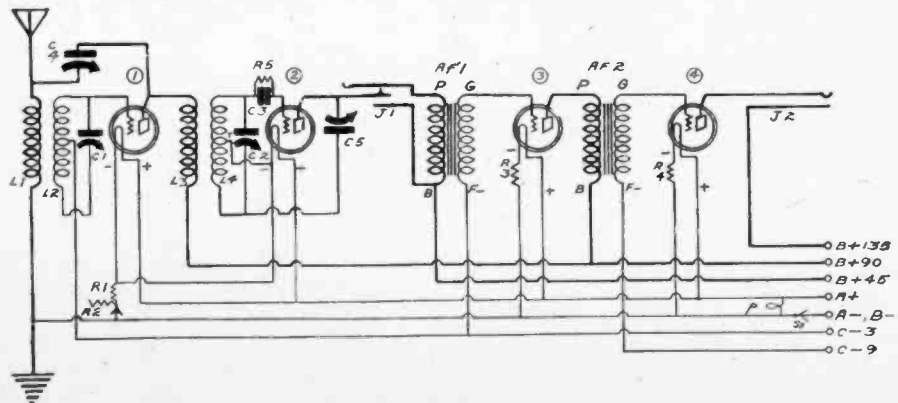

FIG. 10  
The reversely connected jack is shown in this diagram of the new Universal. Last week's diagram showed the jack J1 wired for a detector listening post, not for phonograph pickup.

# Correct Voltage Makes Filament Last Long

Over-Heating Greatly Reduces Duration, Says Expert, Presenting the Case in Favor of the Automatic Resistor

By S. Ruttenberg

Chief Engineer, Radiall Company

Vacuum tubes when properly used, are far from an extravagance. Virtually any reliable make of vacuum tube with genuine thoriated tungsten or oxide-coated filament, operated at proper filament voltage, has a life far in excess of a thousand hours; and it is by no means uncommon to have tubes still going strong after several thousand hours of daily service. Furthermore, reactivation of thoriated tungsten filaments is quite unnecessary in obtaining this long life, provided the filament voltage has been held within the correct limits at all times. Reactivation of a filament is a confession of abuse either through sheer carelessness or pure ignorance; and reactivation, therefore, becomes the pound of desperate cure rather than the logical ounce of prevention.

The filament of a vacuum tube is, of course, the very heart of radio. It gives rise to the circulation of electrons which are the life blood of all radio processes. The robust filament gives off a healthy flow of electrons even at moderate temperatures, while the sickly filament requires an excessive operating temperature which soon brings the useful career of a tube to a premature end.

## Use Special Filaments

Not so long ago, vacuum tubes, still following in the footsteps of standard electric lamp technique, made use of solid tungsten filaments, which had to be heated to bright incandescence in order to provide sufficient electronic emission. For such reason the usual vacuum tube of several years ago required over an ampere of current, which made the multi-tube receiver a costly plaything. Today, however, special filaments are employed, capable of copious electronic emission even at relatively low temperatures and therefore with minimum current. These later-day tubes require only one-quarter and even one-fifth the current of former tubes, and are capable of far greater service in radio reception and amplification.

The special filaments are of two types, namely, the oxide-coated filament, in which a tiny platinum ribbon is coated with a mineral oxide capable of copious electronic emission at low temperatures, and the thoriated tungsten filament in which particles of thorium are included in the tungsten mass. The oxide-coated filament has a long life if properly operated.

The coating slowly evaporates as the tube is used. Excessive filament current, however, results in excessive evaporation, greatly shortening the life of the tube. Likewise with thoriated tungsten, although the process is somewhat different.

## An Interesting Study

Nothing presents a more interesting study in delicate heat application than the thoriated tungsten filament in the usual vacuum tube. When the tungsten mass is heated to the required temperature, the imbedded thorium particles are diffused to the surface which they cover with a layer measured in atoms of thickness. The clusters of electrons represented by the thorium atoms are plucked off by the attraction of the plate, but no faster does this take place than the rapidity with which fresh clusters

of electrons are boiled out of the mass to take their place on the surface. There is a critical temperature at which the thoriated tungsten filament operates with the greatest efficiency, and at which the thorium particles diffuse to the surface just fast enough to keep the latter amply covered.

If the filament temperature is too low, the imprisoned thorium atoms, with their potential wealth of electrons, fail to provide the necessary plate current for the radio function in hand; and if the filament temperature is too high, the thorium evaporates from the filament faster than it can diffuse to the surface. The former condition results in low efficiency, while the latter causes deactivation of the filament, resulting in a marked decrease in current flow from the filament to plate.

## Structure Altered

There is still another change which occurs in the tungsten mass itself when heated to excessive temperature. The tungsten crystalline structure, which has received such careful attention in drawing the metal into the hair-like filament, is altered, thereby greatly shortening the useful life of the tube.

So the matter of radio efficiency and long life from vacuum tubes simmers down to a proposition of correct filament current, which in turn produces just the correct degree of filament temperature. Tube manufacturers see to it that all filaments for a given type of tube are maintained uniform. However, when placed in radio receivers and amplifiers, the filaments are exposed to more or less fluctuation of the supply voltage, which must be compensated for by manual or automatic resistance control in series with the filament or filaments.

## Pointers On Accuracy

The manual method is represented by the hand-operated rheostat, which requires constant adjustment as the battery varies in voltage from full charge to discharge. Also, the rheostat cannot be properly set unless an accurate voltmeter is employed for determining the correct filament voltage. Merely judging by the brightness of the tubes is no indication of proper rheostat setting.

The uncertainties of rheostat adjustment are reflected in exceptionally heavy replacements of tubes. This is especially pronounced in the 199 type of tube, which is particularly critical as regards filament voltage. Again, the necessity of extra manual controls for the adjustment of filaments, in a day when everything tends towards simplicity of operation, is decidedly out of date.

All of which has given rise to the automatic filament control in the form of the Amperite. This device comprises a specially-treated conductor which has the unique property of changing its resistance in accordance with the varying voltage of the A battery or other current source.

## It Is Automatic

Thus when the A battery is fully charged, the device increases its resistance so as to allow only the necessary current to flow through the tube filament. In this manner the filament or filaments of the receiver tubes are operated at the correct temperature at all times, without any at-

## WISE PRECAUTION

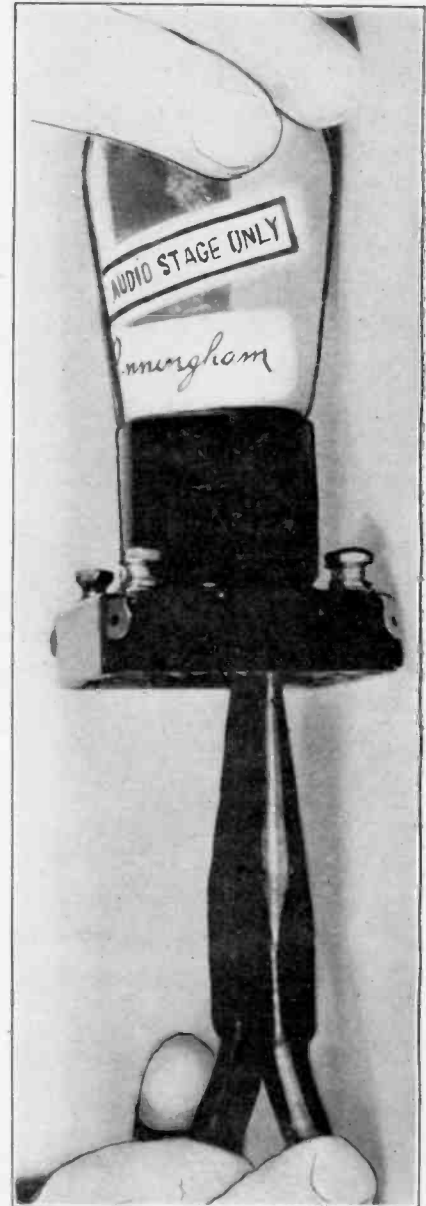

(Hayden)

**POOR socket contacts cause scratchy sounds in a receiver. When building a set always make sure that the socket contact points are secure. Tighten up nuts with pliers.**

attention whatsoever on the part of the radio listener.

The Amperite is not to be confused with the ordinary series resistance, comprising a fixed resistance winding sealed in a glass tube, the sole function of which is to reduce the usual full battery voltage to the desired filament voltage, but with no provision for decreasing this series resistance to compensate for the dropping battery voltage. The Amperite has a coiled filament of special material placed in an elongated glass tube which is exhausted of air and filled with an inert gas, followed by permanent sealing and capping at both ends. In the manufacture of such a device, equipment somewhat similar to the usual vacuum tube machinery is employed, and the shrinkage is considerable because of the close tolerances imposed in order that precision may be gained.

## COMMON IMPEDANCE

A common grid impedance is an impedance which is common to two or more grid circuits. An example is the resistance of a grid bias battery which is used for two or more tubes.

# How to Use a Wave Trap

## It Is Serviceable Even in a Loop Receiver

By James H. Carroll  
Associate, Institute of Radio Engineers

FROM all quarters of the compass come inquiries as to wave traps and their uses and as to what is the best type of trap to use for good results. Evidently there is a great interest in this handy little apparatus, especially under present conditions; and even when the air is eventually cleared a wave trap still will be a good thing to have around.

Take as an example the solenoid wave trap, as represented by the "WEB" model.

There are two main reasons theoretically for the success of this kind of trap and one is because of the solenoid winding which enables the electrical currents flowing through it to establish a more evenly balanced set of lines of force which concentrate themselves in the center of the tubing and upon the concentration point of the variable condenser. In this type of wave trap it has been discovered that this makes for efficiency and has a great deal to do with tuning.

Micrometer adjustment of interference elimination is necessary for rejector circuits. Therefore, when using a wave trap of this variety the condenser plates must be pressed very slowly or the operator will not trap out the unwanted station. This is a point in favor of such a trap.

Wave traps of this type can be effectively used in many different places. If you have been unfortunate in obtaining good results with a wave trap you may not have used it in the right place. In other words, you may have inserted it in your aerial circuit when it would give you the best results in your ground circuit or some other place, instead.

### In the Aerial Circuit

Let us try first the aerial circuit. Disconnect the aerial from your set and connect it to one of the posts on your wave trap. With a short wire connect the other post of the trap to the aerial post of your set from whence you previously removed the aerial. This is the simplest and most usual use of a wave trap, and it is a good one, but under certain conditions it will not prove the most effective. If by this method we do not succeed in perfectly eliminating an offending station on the lower wavelengths let us try inserting our trap in the ground circuit. This is done in the same way except that we substitute the ground wire for the aerial wire. This means is especially recommended for efficient low wave elimination but reports show that it also works equally well with the highest wavelengths and that also by this method additional stations have been tuned with a wave trap of the design we are discussing.

Now, if we are working with a loop, we can connect our trap in the grid circuit, the most approved method of eliminating interference in such a case and the only way of using a wave trap with a loop set. First locate your grid wire that goes to the tuning device in your set, either coil or condenser. Disconnect this wire at the point of contact with the grid post of the socket. Connect it to one end of a flexible wire about two feet long. Connect another piece of flexible wire of the same length at the place from which you disconnected the other wire and run these two wires outside your set to your wave trap, attaching one wire to one post of the trap and the other to the other post of the trap. You are now ready to eliminate interference. This method, even if it is a little more troublesome to try out, is well worth while, because it will make any set selective.

Another means we may use is the aerial and ground shunt, which is one of the oldest methods known and among the most popular. All that need to be done to use this method of installation is to run a wire from the aerial post of the set without disconnecting the aerial wire to one of the posts of the wave trap. Then run another wire from the ground post of the set to the wave trap. Although no tuning can be done with a wave trap used this way it functions as an excellent trapping system and stations in the vicinity of the set can be dominated by this means.

Do not confuse a wave trap of this type with an apparatus such as the Centralab Short Wave Selector which is what the name implies and not a wave trap. It fills a very definite function of its own and can be used very satisfactorily in conjunction with a trap of the type we have selected as the best.

While our testing was being done and before this article was completed, a letter came to hand from a fan signing himself a Junior Radio Bug asking for practically the information given in this text, and among other things inquiring as to what became of the trapped station when it was captured, probably figuring that it remained in the trap ramping around

and beating its waves against the walls in a futile effort to escape.

Well, Junior, you have staggered us here as we haven't the slightest idea as to what becomes of the invading station; our idea is that perhaps, getting its nose or its tail pinched in the trap, it tears away on the trail of other prey in the form of sets not protected by a beneficent wave trap. The earliest form of trap of any kind known to history was a pit dug in the ground by the cave man in front of his cave apartment. This was covered by twigs, branches and grasses so that it looked like a solid surface. Along came the marauding mammoth, in search of meat to vary his vegetarian diet, and tumbled in with a crash that shook the row of caves and dislocated every aerial in miles. Then, all that remained for Mr. Cave Man and his tribe was to squat around the trap and sing and howl in chorus until they sang the threshing behemoth to death in which case they became the partakers of meat. It is evident, then, that the inventor of the wave trap modeled it upon this efficient device, taking a hole, or a pit, as it were, enclosing it in bakelite, disguising it with a solenoid winding and adding the pinching condenser that squeezes the invading station until it howls for mercy.

## Audio System Easily Tapped by Tube Base

By Asa Schenck

Many fans have complete sets and are satisfied with the tone quality on local stations, but find the sets a little weak on DX. That is, the audio portion is satisfactory, but the radio portion needs attention. Still they do not wish to keep on tearing the set apart to find the best DX hookup, etc., this being due more to friend wife than to the fan himself. However, with the aid of an old tube socket, this problem has been solved. How it is done is shown in the electrical diagram shown below.

The audio portion of any set is used. Any hookup which you may have seen in a magazine and wish to test out may be used. The whole stunt is to save yourself the trouble of building up any audio stages, and disrupting your complete set.

Now procure an old tube base. Break the glass, and solder three leads to the prongs on the inside. The correct markings can be found by inserting the base in a socket. Only the P and F posts are used. Pieces of gummed paper should be placed over the leads for identification. These leads should be about five feet long. Now to use, remove the detector tube from the receiver which you always use. Put the new tube base in its place. Remove the antenna from its place on the always used receiver and attach to the new set. Bring the leads from the socket in the old receiver to the binding posts on the new one, with its equivalent markings. This stunt should be popular with DX hookup hunters.

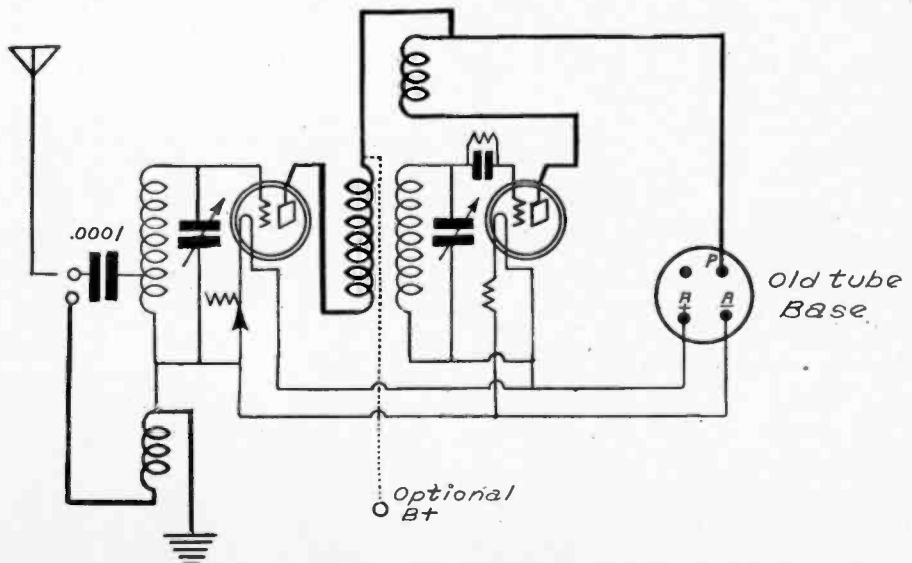

THE CIRCUIT diagram of a suggested receiver to be used with the audio portion of your set.



# Control Board Appointed; No Money Is Provided

Bullard, Sykes and Dillon Confirmed by Senate, While Caldwell and Bellows Are Not, But Get Coolidge's Recess Appointment

Washington.

Despite the complicated situation resulting from the failure of Congress to appropriate the money for the Federal Radio Commission, there is little doubt that the newly created board will be at its appointed task of clearing the air of interference.

This is the opinion of high officials of the Government. They regard it as imperative that the money be obtained in order that the Radio Commission may get to work.

It appears to them that Secretary of Commerce Hoover will be called upon to do the rescue act. There is assurance that Mr. Hoover's department could provide the money without legal complications, and that an amount sufficient for the purpose might be made available.

### Hoover Ready to Help

The proposition has already been put up to Mr. Hoover.

Mr. Hoover is reported as believing that the radio situation calls for immediate relief; that the sooner the Commission begins to function, the better chance it will have of ridding the radio channels of interference and confusion. So if called upon to do so, Mr. Hoover may seek to find a way to provide the money from appropriations made for the Department of Commerce.

Through failure to pass the deficiency appropriation bill which would have provided the money necessary for the Commission to function, the Senate left radio regulation in much the same condition as the mix-up in broadcasting wavelengths.

### Three Confirmed

Before adjournment, the Senate confirmed three of President Coolidge's selections for the Radio Commission—Rear Admiral William H. G. Bullard, retired; Judge Eugene O. Sykes, of Mississippi, and John F. Dillon, of San Francisco. At the request of Senator C. C. Dill, co-author of the law, action was postponed on the nominations of Henry A. Bellow of Minneapolis, and Orestes H. Caldwell, of New York. Senator Dill claimed that Messrs. Caldwell and Bellows were "Hoover hand-picked" and would stand a little investigating.

Later recess appointments were given by President Coolidge to Caldwell and Bellows.

### Risk For Two

The President does not consider that the failure of the Senate to confirm the nominations of Bellows and Caldwell amounts to an objection to their appointment. In fact, the President has been assured by Senators who opposed the immediate confirmation of these men that there is no very good reason for not giving them recess appointments, provided they are willing to serve without pay until confirmed by the Senate.

If Bellows and Caldwell make what the Senate considers to be good records for themselves during the Summer months, or at least if they do nothing to which the Senate can object, there is little doubt they would be confirmed immediately after Congress meets in December.

If the Senate does not like the way they

conduct themselves in office, they will have served without pay.

In this manner has the Senate contrived to keep a club over the heads of two of President Coolidge's appointees.

### May Meet Once

If the Commission holds one meeting to extend the life of broadcasting licenses until next January and then adjourns because of lack of money, a unique situation would result. It is the opinion in some circles that the foregoing may be the case.

Under the provisions of the law, after adjournment of the first meeting of the Commission, all matters would be referred to the Secretary of Commerce, who is given authority in an emergency to settle all matters, pending a meeting of the commission.

With the Commission handicapped because of an empty pocket book, it would leave Mr. Hoover practically as the "czar" of the air until Congress makes an appropriation for the Commission during the next session which begins in December.

## Army Band Heard Weekly Over Chain

The weekly concerts of the United States Army Band are one of the broadcast features heard from WJZ and associated stations of the National Broadcasting Company, WRC and KYW, on Wednesday nights at 7:30 P. M., E. S. T.

The United States Army Band, one of the leading military bands in the country, was organized in the Spring of 1922, when ninety musicians were selected for their outstanding ability from the various bands of the United States Army and concentrated at Fort Hunt, Va. General Pershing was then Chief of Staff and he was behind the movement to give the United States an Army Band that would compare favorably with the military bands of any other nation.

In September, 1922, the United States Army Band was moved to Washington Barracks, and Capt. William J. Stannard was appointed band leader and Master Sergeant Willis S. Ross, drum major. The band has furnished the military music for practically all of the important military and diplomatic affairs in Washington and other parts of the country. They led the funeral procession of the late President Warren G. Harding, the Defense Day Parade, the President Coolidge Inaugural Parade, and furnished an orchestra for the Inaugural Ball, and shared honors with the Marine Band and the Navy Band in the park concerts during the Summer in Washington, where other bands participated.

## Hall New Director of WRNY Programs

Alfred Hall recently assumed charge as program director of WRNY. Mr. Hall has had a wide experience, not only in broadcasting, but as a musician and actor. Mr. Hall has been assistant program director and chief announcer of WRNY for more than a year.

## COOLIDGE'S CHOICE



(Henry Miller)

REAR ADMIRAL William H. G. Bullard, U. S. N., retired, of Media, Pa., scheduled for the chairmanship of the Federal Radio Commission by President Coolidge.

## Japanese Turning From Crystal Sets

An improved market for radio sets in Japan is expected, the United States Department of Commerce announced, on account of plans for increased broadcasting facilities in that country. The full text of the statement follows:

The Tokyo Broadcasting Station has decided to erect in or near Tokyo a new station of 10 kilowatts to increase its subscription list, state advices to the Department from the office of the commercial attache at Tokyo. It is expected that this new station will be ready for operation in the fall of 1927.

The present Tokyo broadcasting station of 1 kilowatt is not operating at capacity and new subscribers are few in number. At present there are approximately 326,000 subscribers in Tokyo and within a 100-mile radius of the city and it is felt that this number can be greatly increased with the opening of the more powerful station.

Of the present subscribers 80 per cent. use crystal sets. At present the market is rather dull and dealers are endeavoring to dispose of their stocks so that they may import new and improved sets, since the Japanese people desire the latest improvements. Although the present market is slow it is expected locally to improve in the near future.

## Newspapers Change Their Program Policy

New York newspapers having decided to print only skeleton radio programs, with all manufacturers' names deleted, and not having pleased radioists by this course, one newspaper—"The Telegram"—broke away from the plan. "The Sun" and "The Evening World" followed suit.

The American Newspaper Publishers' Association recently voted in favor of the "cut program" plan.



# Hoover Lauds Appointees; Calls the Law Adequate

Means of Carrying Out His Recommendations Now At Hand, He Says, and Prophecies End of Interference Troubles

By *Herbert Hoover*  
Secretary of Commerce

The whole subcurrent of the fight over radio legislation during the last two years has been to prevent the radio listeners being dominated by politics or any other selfish interests in control of broadcasting.

Three years ago the Department of Commerce stated there must be Federal regulation owing to the limited number of wavelengths and, therefore, the inability of all persons to broadcast without mutual destruction of all service; that this limitation on stations would result directly in a privilege; that the public interest was, therefore, involved; that the determination of who should exercise this privilege would result in a discretionary or semijudicial authority which should not rest in any one person or under the control of any political group, region or otherwise.

Also that there should be a maintenance of a full representation of local stations distributed throughout the whole of the cities and towns of the country in order that radio should be the agent of distribution of local as well as national talent; that multiplicity of stations is the only guarantee for freedom from control and freedom of expression.

## Nature of Recommendations

In order to attain these objects the Department recommended legislation providing that the determination of who should use the wavelengths and the power that should be applied should be exercised by an entirely independent non-political commission chosen from different sections of the country; that its decision should be based upon public interests; that there should be an appeal to the courts from decisions of the Commission; that the large administration job of putting into effect the decision of

this Commission should be vested in one the existing administrative departments and thus avoid the creation of duplicating agencies in the Government. The radio industry and radio listeners have consistently supported these views.

## Results Accomplished

All this has at last been accomplished and it is sealed through the appointment by the President of a commission of five absolutely independent men, having no political activities, representing the different sections of the country, each of whom contribute essential expert skill and experience to the work of the commission.

I am confident that this commission will act at once in the interest of the listeners to energetically clear up the chaos of howls which arise through the interference of stations and is the result of the long delay in securing this legislation. As the decisions of who shall have wavelengths must be based on public interest, I have no fear that those many radio stations which have developed high skill and sense of service to their listeners will be fully protected.

## Hampered by Lack of Funds

The failure of the deficiency bill in the Senate deprived the commissions of funds with which to either pay its salaries or other expenses of the Commission. It has been suggested that as the law provides that the Secretary of Commerce shall exercise the powers of the Commission in its absence that the Commission should owing to its lack of funds merely assemble and adjourn. As this would defeat the purpose we have all sought, I am inviting the members of the Commission to assemble in Washington and if the Commission desires the Department of Commerce will cooperate to the best of its ability in finding some way of enabling it to function through the loan of clerical staff and otherwise.

## Brief Sketches of Careers of Members of New Radio Board

**O. H. Caldwell** was born in Lexington, Ky., in 1888, and has been editor of electrical and radio magazines since 1907, when he succeeded Dr. Lee De Forest as technical editor of the *Western Electrician*, Chicago, and its successor, *Electrical Review*. He has been the editor of both *Electrical Merchandising* and *Radio Retailing*. He is a graduate of the electrical engineering department at Purdue University with special work in electrical communications, following preliminary training in Berlin, Germany. He is a member of the American Institute of Electrical Engineers; Radio Committee, American Engineering Council; director, New York Electrical Board of Trade; chairman, Surveys of General Merchandising Committee, National Electric Light Association; member, Society for Electrical Development, New York Electrical Society, New York Electrical League; member Lotus Club, New York,

and Indian Harbor Yacht Club, Greenwich, Conn., Republican.

**Rear Admiral William H. G. Bullard** was graduated from the Naval Academy in 1886. He served on the Columbia in the Spanish-American War, 1898; navigator on the Maine, 1905 to 1906; as executive officer on the same boat, 1906 to 1907; at the Naval Academy, 1907 to 1911; organized department of electrical engineering there; commandant of San Francisco, 1911 to 1912; superintendent Naval Radio Service, Arkansas, 1916 to 1918.

He served in the Atlantic fleet and in the American division of battleships in the British guard fleet in the World War, was a member of the Interallied Commission at Malta; commanded the United States naval forces in the eastern Mediterranean; member Interallied Commission to put into effect the naval terms of the armistice with Austria-Hungary; and received surrender

of the Austro-Hungarian fleet. He was a member of the Interallied Conference at Paris in January to August, 1919; director of naval communications, March, 1919, to 1921; commander of the Yangtze patrol force, United States Asiatic fleet, 1921-22, and retired on September 30, 1922.

He was a delegate to the International Safety at Sea Conference at London in 1913. He is a member of the Institute of Radio Engineers; Washington Society of Engineers; Veterans of Foreign Wars of the United States; Naval and Military Order Spanish-American War. His medals and decorations include West Indian and Philippine campaigns; Victory Medal; Distinguished Service Medal; Navy Department; Commander Legion of Honor, French; Order of Knights of Polonia Restituta, Poland. He is a member of the Army and Navy Club, Washington; Officers' Club Annapolis, and the New York Club.

**Eugene O. Sykes** was born in Aberdeen, Miss., July 16, 1876, and studied at St. John's College, Annapolis, and the Naval Academy and received an L. L. B. degree at the University of Mississippi in 1897. He practiced law at Aberdeen, Miss.; was Democratic Presidential Elector at large from Mississippi in 1904. He was appointed a justice of the Supreme Court of Mississippi in 1916 and was elected to the same office the same year for a term ending 1924. He retired then to resume the practice of law. He is a member of the Delta Kappa Epsilon, a Mason, an Elk, and Woodman, and a member of the Sons of Confederate Veterans.

**Henry A. Bellows** was born in Portland, Me., September 22, 1885. He is a graduate of Harvard and was on the staff of that University for a time. He was managing editor of the *Bellman*, Minneapolis, 1912-19; the *Northwestern Miller*, 1914-25, and director, Gold Medal Radio Station since 1925. He served as Colonel of the Minneapolis Home Guard and the Fourth Regiment of Minnesota infantry from 1917 to 1919. He is a member of various college fraternities and a noted author.

**John F. Dillon** was born in Belleville, Ohio, March 6, 1866, and enlisted in the United States Signal Corps on April 15, 1894. He served as a telegraph operator and general electrician; was discharged in 1899 as a sergeant. He was appointed a Radio Inspector of the Department of Commerce from Chicago and was transferred to San Francisco in 1915 as supervisor of radio for the sixth district where he has since served. He returned to the military service in the Signal Corps at the outbreak of the World War and saw service in France. He was discharged at the end of the war with the rank of Major and now has the rank of Colonel in the Reserve Corps.

## Must Find Way Out, Senator Dill Insists

"A most unfortunate situation, and I hope some way can be found for the Commission to function as the law contemplates."

This is the comment of Representative Wallace White, co-author with Senator C. C. Dill, of the radio law, on the failure of the Senate to provide an appropriation for the Federal Radio Commission.

Senator Dill shares the same view. But he is more positive that a way can be found for the Commission to function anyway.

"This work is too important and our Government is too powerful not to be able to get around this proposition," says Senator Dill.

## EDISON'S ADVICE

"Every family that can afford a radio should use it," said Edison at his 80th birthday party.

# Yazoos and Even Chengs Win Favor at Microphone

So Does the Bathyphon, Which Is Not a B Eliminator Tube, But Like the Others, a Queer Musical Instrument of Charming Tone

By J. T. W. Martin

If Spring house cleaning this year brings to light any odd-looking musical instruments, don't relegate them to the ash heap without first taking them to the nearest broadcasting studio and having them tested over the air. Broadcasting has dragged plenty of almost forgotten instruments into prominence, and it has helped to popularize a host of new ones. And the process will undoubtedly continue just as long as musical tools which register through the microphone with new qualities of tone can be discovered or created.

The members of the program departments of the National Broadcasting Company, who are responsible for the booking of artists who appear over the air from stations WEAJ and WJZ of New York, WRC of Washington, and KFKX of Hastings, Neb., have become immune to outlandish names for musical instruments. No longer can a performer create a stir by declaring emphatically that he is a past master of the bathyphon or a wizard with the cleng.

Instead, they ask him to play it before a microphone in the studio, so that they may hear it in a loudspeaker and decide whether or not it is suitable for broadcasting. The program builders have even ceased to be amused when the artist produces from his pocket an instrument bearing a strange, seven-syllabled name, or when he states that a truck is outside bearing an implement whose name can be recorded in three letters.

## Many Are Old

Many of the weirdly named instruments are old ones. Others have just come on the market, but these are usually adaptations or mechanical variations of ancient musical tools. Some of them have proved unsuited to broadcasting, but plenty of them have made established places for themselves in the ranks of instruments well suited to microphone work. At any rate, the program builders are always open-minded. They refuse to pass judgment until the mike has had its say.

Before the advent of broadcasting, few people had heard of the celeste, although it had always been a part of every full symphony orchestra. The instrument consists of a number of steel plates which are played by being struck with small hammers, a description which sounds considerably less melodious than the sweet tones which the celeste produces in broadcasting. Today, the instrument is being used by many popular orchestras in their concerts over the air.

The xylophone, the marimba and the cymbalum, all implements similar in construction to the celeste, have also been brought to fame largely by radio, and the vibraphone, which produces its tones from metal tubes rather than from strings or discs, has been designed especially for broadcasting purposes.

Almost anything can be played these days. Witness the sweet, swinging tones of a saw when struck with a padded hammer and bent to produce various notes. The cigar-box banjo and the "one-string fiddle," made from a cigar box and a broomstick, in the hands of experienced players, produce real music of a startling-

ly different character when heard over the air.

## Early Piano Types

Other instruments which have proved excellent broadcasters are legion. They include the zither, a form of Irish harp, once very popular but little heard of late, until broadcasting came into its own. The dulcimer and the harpsichord, forerunners of the modern piano, are making new musical reputations, thanks to the microphone. Even the Jew's harp is gathering laurels for itself.

The recent Russian invasion of the American stage brought with it the balalaika, a strange-looking mandolin possessing a triangular head. Balalaikas arrived in the United States in all sizes and previous conditions of servitude, and for a while, they were widely heard. Then came a slump in balalaika stock, when the Russian influence declined. Yet today, because of the effectiveness of the instrument over the air, the balalaika is stepping into a position just below those occupied by the saxophone, the banjo and the ukulele as broadcasting implements.

The present status of the three last named musical tools illustrates what radio can accomplish. All of them register much more agreeably in a loudspeaker than they do when heard directly by the ear, and since the growth of broadcasting, the kindness with which the microphone treats them has carried the three to a prominence they could never have attained in the same period of time through any other medium.

In the same class is the Hawaiian guitar, with its plaintive appealing tones produced by sliding a steel bar along the strings with the left hand while they are being strummed with the right. It was responsible for the great vogue for Hawaiian music in America some eight or ten years ago, but it has required the aid of the microphone to revive its popularity.

The accordion is another implement which is liked by the mike, and at the present time, it is being heard both as a solo instrument and as an adjunct to several leading dance orchestras.

## Humming Popular

The vividness which the microphone lends to humming has brought about a whole family of musical tools built on the same principle as the paper-wrapped comb with which all children at some age amuse themselves. They are known as kazoos, yazoos and by other outlandish cognomens and they assume a wide variety of shapes, but essentially they are the same. When used by persons possessing good voices, they produce music of unusual quality in a loud speaker.

Another large group of tools which succeed in convincing the microphone that they can originate music has sprung from the tin whistle and the ocarina, commonly known as the "sweet potato," an instrument made of clay and enameled black, shaped much like the vegetable from which it takes its name. The members of this family of implements also assume strange shapes and are known by equally weird names, but all of them produce unusual and not displeasing sounds when used in broadcasting.

## QUELLS NOISE

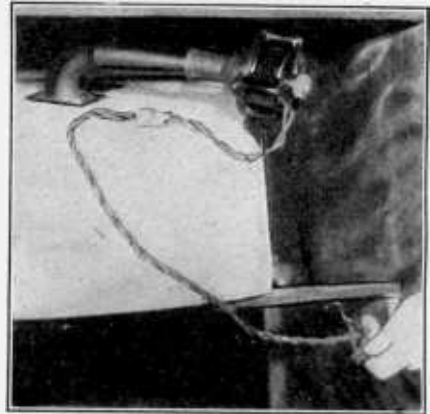

MICROPHONISM MAY be caused by a dangling phone cord of a speaker in a console. Tape cord to inner side of console for prevention.

## Weekly Revue Stresses Strides of Program Art

The National Weekly Revue, which was broadcast by WJZ and the stations of the National Broadcasting Company's Blue Network, WBZ, KDKA, and KYW, at 9:30 o'clock Eastern Standard Time, Sunday night, March 13, offered to the radio audience an opportunity to study the strides which are being made in the development of the newly founded art of radio presentation. The legitimate stage originally started with the presentation of drama in its simplest form, the scenery in the early days being largely imaginary. Later, comedies were introduced and still later music began to take its place in the form of operas.

Again comedy succeeded drama and the operas took on a lighter tone and gradually developed the operetta or light opera. The next development in the matter of stage entertainment was the introduction of vaudeville in which the audience was given a combination of drama and comedy, with musical selections of both serious and frivolous nature. The latest development along this line of entertainment has been the modern revue which combines sketches, music, dancing and other forms of entertainment.

Radio has followed to a great extent in the footsteps of the legitimate stage in its development but as the audience is blind to the actions within the walls of the studio, sound only is the means used in the entertainment. In the early stages of radio broadcasting development, the programs featured one kind of music at a time. Later radio drama was introduced and an effort made to convert into sound which would normally occur on the legitimate stage. These efforts were successful and again the art of radio broadcasting took a step forward and combined music with drama to get a new form of presentation—a radio musical show.

The newly devised National Weekly Revue presents the latest step of broadcasting development, the combination of all known successful methods of providing loud speaker entertainment. Dramatizations, sketches, duologues, monologues, musical stories, orchestral selections, vocal and instrumental solos, personal appearances and comedy have been combined into a single broadcast feature to bring about this new effort. In short, radio in five brief years of its existence, has developed approximately to the same degree that the legitimate stage has taken several centuries to reach. The National Weekly Revue is to the radio audience what the musical revues are to the audiences of the legitimate stage.

## Damrosch, Beck and Quartet in Beethoven Event

The National Broadcasting Company in arrangement with the Columbia Phonograph Company, the sponsors of Beethoven Week (March 20-26) with a broadcasting program to be sent through stations in twenty-two cities of the United States, will join in the great national celebration of the composer's centennial. "The Beethoven Hour" will be sent out through WEAF and associated stations of the Red Network from the Lyceum Theatre, New York City, on Saturday evening, March 19, at 9:00 o'clock, Eastern Standard Time (8:00 o'clock, Central Time).

The main feature of the first Beethoven week broadcasting program will be a piano lecture recital on Beethoven's "Fifth Symphony" by Walter Damrosch, conductor of the New York Symphony Orchestra, an authority on Beethoven and already well-known to the radio audience. Mr. Damrosch will explain the meaning of Beethoven's "Fifth Symphony" and play its important themes at the piano while talking. Assisting him in this program will be the Musical Art Quartet, using four rare Stradivarius instruments presented to them by Felix Warburg, the banker. The members of this quartet are Sasha Jaobsen, first violinist; Bernard Ocko, second violinist; Louis Kaufman, viola, and Maria Romaert Rosnaoff, 'cellist. The quartet will play two movements from the great quartets of Beethoven and will assist Mr. Damrosch in his presentation of "The Fifth Symphony".

Mr. Damrosch, who, for four decades has been the conductor of the New York Symphony Orchestra, is said to be the first person to give a Beethoven cycle in this country. In 1909 he gave the complete nine symphonies of Beethoven in order but grouped with them other works of the same period.

In commenting upon his broadcasting of lecture recitals in the last few months as related to conducting the New York Symphony Orchestra for nearly half a century, Mr. Damrosch said: "I have learned more of the inner nature of Americans through my broadcasting programs than in the forty-two years as an orchestral conductor. These broadcasting programs have enabled me to enter into the homes and the inner life of the American people."

A brief address concerning Beethoven will be delivered by James M. Beck, solicitor general of the United States, an eminent barrister and diplomat.

The program will be broadcast by WEAF, New York; WEEI, Boston; WJAR, Providence; WTAG, Worcester; WGR, Buffalo; WFI, Philadelphia; WRC, Washington; WCSH, Portland, Me.; WCAE, Pittsburgh; WTAM, Cleveland; WWJ, Detroit; WSAI, Cincinnati; WGN, Chicago; KSD, St. Louis; WOC, Davenport; WCCO, Minneapolis-St. Paul; WDAF, Kansas City; WGY, Schenectady; WHAS, Louisville; WSM, Nashville; WSB, Atlanta; WMC, Memphis.

The final Beethoven Hour will be broadcast on Saturday, March 26, at 9 P. M., E. S. T., and through the same stations.

### WMAQ ON RED CHAIN

Another broadcasting station located in Chicago has been added to the Red Network. The broadcaster is WMAQ, of the Chicago "Daily News," which also uses the call letters WQJ during certain periods of the day. At present this newest addition is sending out on its wave programs emanating from WEAF on Tuesday and Thursday evenings.

## THE LIFESAVER



(Wide World)  
A SWISS MOUNTAIN guide, equipped with a complete radio receiving apparatus, renders first aid to a helpless climber who signalled for aid, with a transmitter, one of the many located along the dangerous spots on the mountain. This service takes the place of the St. Bernard rescue packs.

## Joy Appointed to Fill Executive Post at WEAF

Ensclosed in a private office opening off the spacious reception lobby of WEAF, Room 412, 195 Broadway, will be found a pleasant and business-like young man, who occupies a desk in the same office as Phillips Carlin, manager of WEAF. This young man who signs his name above the title "assistant manager of WEAF," is known to thousands of radio listeners, for he is none other than Leslie W. Joy, former announcer of WEAF's staff.

Joy was born in Tacoma, Washington. Soon the family went East and entered their son in the Peekskill Military Academy, Peekskill, N. Y., where he was graduated with honors. He then entered the University of Pennsylvania and, at the termination of a four-year course, received a B. S. degree for economics. When the United States declared war, Joy enlisted, became a sergeant in the Army Ambulance, and later an Artillery Balloon Observer.

It was while Leslie Joy was a Freshman at the University of Pennsylvania that his musical ability was first recognized. In his senior year he was leader of the glee club. He has a bass-baritone voice and has appeared frequently in concert and oratorio performances, and most especially with the Savoy Opera Company in presenting Gilbert and Sullivan operas.

## Beginner's Dictionary

**Phase difference**—This is often spoken of as simply phase. The phase difference is the angular difference between two periodic events, such as two electric alternating currents, or a current and a voltage. If the phase is measured from the time that one of these is zero then the phase difference is simply the phase of the other. Suppose that the current in the plate circuit of one tube is maximum at a certain instant and that the current in the next plate circuit in the same amplifier is minimum at the same instant. Then the phase of the first is 90° and the phase of second is 270°, and the phase difference between the two is 180°. They are then said to be in opposite phase, because at every instant the two currents are flowing in opposite directions. They may also differ by other angular values. Thus one current may lead the other by a certain

angle or it may lag behind by some angle. A pure inductance retards the phase 90°, a perfect condenser advances the phase by a like angle. When there is resistance in series with coil or condenser the retardation or the advancement is always less than 90°. A coil having a resistance of 1,000 ohms and a reactance of 1,000 ohms at some frequency will retard the phase of a current of that frequency by exactly 45°. Similarly, a circuit having a condenser of reactance of 1,000 ohms at the same frequency and a resistance of 1,000 ohms will advance the phase 45°. When both the coil and the condenser are in series with a total of one thousand ohms, the coil retards the phase exactly the same amount that the condenser advances it, and the net result of the two is no change in the phase. They are then in tune with the frequency.

## WOODEN BRACE PROTECTS PANEL

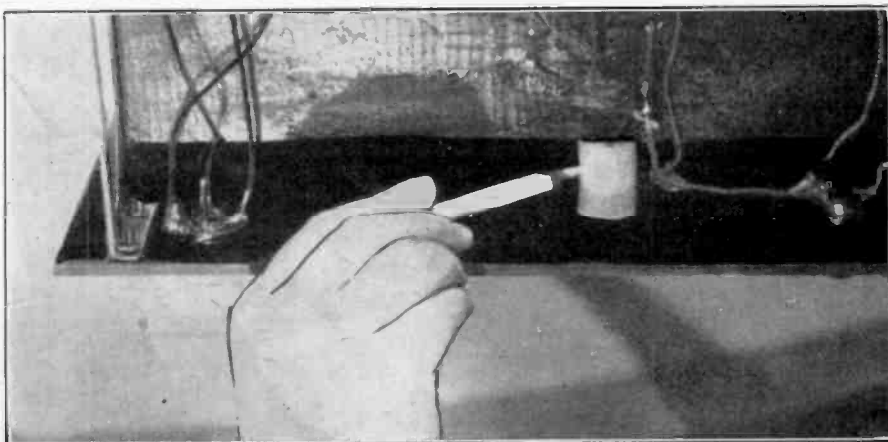

(Hayden)

TO PREVENT warping of the front panel when it is free of the baseboard, put a piece of wood between the subpanel and the panel. The wood may be fastened to the baseboard with a screw. No connection need be made to the front panel.

## Music Programs at Peak; Balancing is the Problem

Aylesworth Points to Greatest Singers and Orchestras  
Already Heard—Sees Big Field for Adult  
Education Through Broadcasts

Boston.

The establishment of an endowed University of the Air, which would democratize higher education in the United States, was predicted by Merlin Hall Aylesworth, president of the National Broadcasting Company, in an address made before the Boston Chamber of Commerce. "It will not be long, he declared," before the radio audience in this country will exceed 30,000,000 people.

"The day has almost arrived," he said, "when broadcasting will have no more worlds to conquer in the field of musical achievement. We cannot put on the air stars greater than the greatest operatic singers which the world now knows. We can go no further than to present the most distinguished artists of the concert stage. We cannot broadcast greater symphony orchestras than those put on the air in recent weeks. Our problem in this respect is so to diversify and balance our programs as to maintain the highest standard of musical and entertainment performance in the air."

### Old Theories Upset

"Studies being made by the National Broadcasting Company," Mr. Aylesworth declared, "are upsetting some time-honored theories as to public taste.

"Exalted critics who foresee the intellectual doom of the nation, because of what they claim to be the great preponderance of lowbrows over highbrows, might be led to dry their tears by our own discoveries," he said.

"We find that it does not require a college or musical education to appreciate the best in music and entertainment by broadcasting; that both those in the cities and those isolated country districts, poor and rich alike, enjoy the best which we can bring into their homes. Lack of opportunity to hear the best in music, we find, rather than marked distinctions of taste, has held back general musical appreciation in the past.

"In so far as broadcasting is able to reflect a high standard of musical, educational and cultural influences, it is destined to be a most beneficent influence for the entire country.

"Radio broadcasting has thrown the door wide open both to those who would raise the level of national culture by greater educational opportunities, and to the millions who yearn for some of the advantages of higher education. The problem of adult education, for one thing, is to reach the adult in his home rather than to bring him to the classroom. From this standpoint, at least, broadcasting can be made the greatest agency of public education."

### Committee of Notables

"The educational, social, religious and cultural problems of broadcasting," Mr. Aylesworth asserted, "are now being studied by the Advisory Council of the National Broadcasting Company. In addition to Owen D. Young, co-author of the Dawes' Plan, the Council membership includes Elihu Root, Charles E. Hughes; Dr. E. A. Alderman, president of the University of Virginia; William Green, president of the American Federation of Labor; Dr. Charles

F. MacFarland, general secretary, Federal Council of Churches of Christ in America; Walter Damrosch, conductor of the New York Symphony Orchestra; Mrs. John D. Sherman, president of the General Federation of Women's Clubs; Francis D. Farrell, president of the Kansas State Agricultural College; Dwight W. Morrow, of J. P. Morgan Company; Gen. J. G. Harbord, president of the Radio Corporation of America; Henry S. Pritchett, president of the Carnegie Foundation; John W. Davis of New York City; Henry M. Robinson, president of the First National Bank of Los Angeles; Gen. Guy F. Tripp, chairman of the Board of the Westinghouse Electric and Manufacturing Company; Julius Rosenwald, of Chicago, and Morgan O'Brien, of New York."

Mr. Aylesworth described the growth of the radio industry in which broadcasting formed the keystone.

### Wonderful Growth

"It is fair to measure the phenomenal development of broadcasting service in the United States," he pointed out, "by the figures of the radio industry. Consider that in 1920 the total figures of the radio industry of this country hardly aggregated more than \$1,000,000 for the year; that within two years, in 1922, radio was a \$60,000,000 industry; that in 1923, the last figure was more than double and that the approximate business of the radio industry in the United States was \$136,000,000; that in 1924 the total had jumped approximately to \$360,000,000, touching over \$400,000,000 in 1925, and reaching the impressive goal of a half a billion dollar industry in 1926, according to latest estimates.

"From a few hundred radio sets in use in this country in 1921, the total has risen to over 6,000,000 sets in use here at the beginning of this year. Over 2,500 manufacturers are represented in the radio industry and almost 30,000 channels of distribution have been created to serve the public demand for radio equipment.

### Who Shall Pay?

"And yet it is interesting to note that during the six years of this tremendous development discussion raged on the question of: Who is to pay for broadcasting? Where shall we find the foundation for a permanent broadcasting service in the United States? Like the ancient tale of the lawyer advising his client already behind the bars, 'Why, man, they can't possibly put you in jail for this!' there were many economic experts who shook their heads and that broadcasting could never go on like this. Broadcasting could not give the public something for nothing and yet hope to survive.

"Despite this, more individuals, corporations and groups have been, and are, willing to erect broadcasting stations in the United States, than there are wavelengths to accommodate them. Nevertheless those who had noted how some countries had handled the problem of broadcasting by national control or through government subsidy, pointed out to our own ineptitude in meeting the situation. Such is the vitality of the American idea in industry."

## BAIRD SENDS TELE

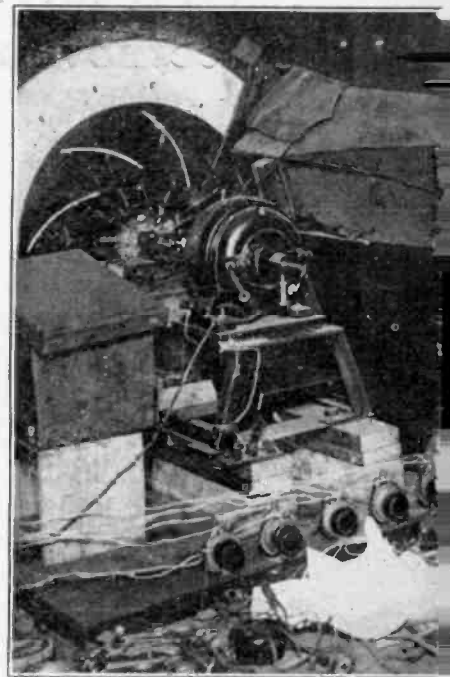

(Wide World)

**JOHN L. BAIRD**, the young Scotch inventor from which he sent moving scenes by radio, is shown here with his rapid method of wiring. Compare these with the machine-like precision of E. F. W. Alexanderson, of the General Electric Company, the experimenter on this side of the Atlantic. The results of the experiments by these two men are being watched with eager eyes by fans and engineers.

## FILTERED OUT

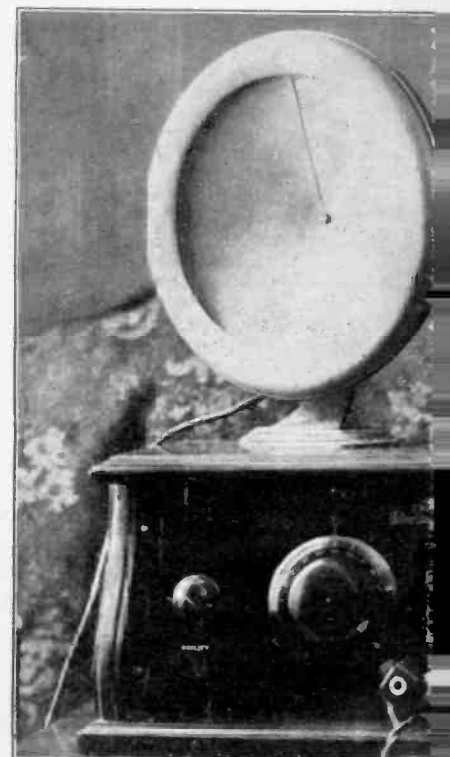

(Carroll)

**EXCELLENT TONE** quality may be obtained by connecting the Tone Bridge to the output posts of the speaker from the hi-tube, which is a power type. A variable resistor, a part of the bridge, varies the output, may be placed atop of the receiver, as



VISION NINE MILES



ntor, is shown in his laboratory in London, dio to Harrow, nine miles away. Note his s, as denoted by the mechanical connections. sion of television apparatus used experimen- eneral Electric Co., a leading television ex- Which method do you think will win out? two noted experts are being watched with rs as well, both here and abroad.

OUTPUT ON TOP

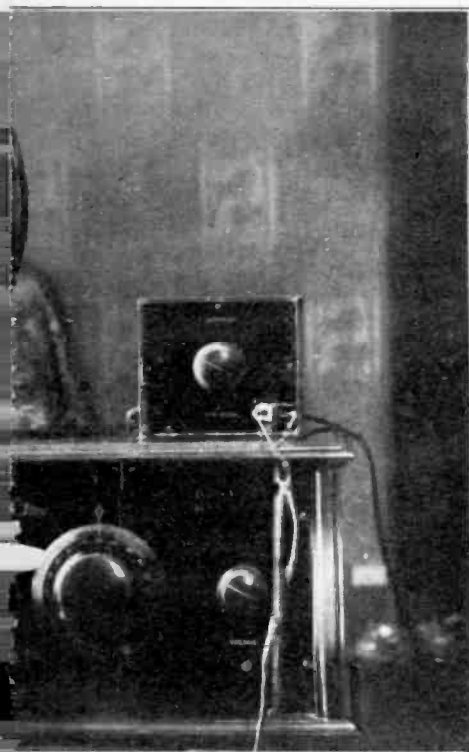

ained when a cone speaker and a Jaynson of a standard receiver. The bridge also gh voltage applied to the plate of the last sistance connected in series with one of the e volume. The tone bridge, or filtered out- it was in this case, next to the Acme cone.

# Australia Beam Service to Bring Messages to U. S.

Wireless Between Canada and Melbourne Suburb to Be Supplemented by Land Wire Telegrams—Britain and Europe Reached, Too

*Beam wireless stations are being erected in Australia by the Marconi Company for the Amalgamated Wireless (Australasia), Ltd., for direct commercial services to England and Canada, state advices to the Department of Commerce from Trade Commissioner E. G. Babbitt, Sydney, Australia. These stations will be available for all classes of overseas telegraph traffic in competition with the cables, and it is stated that the rates to and from England will be lower than the present-day cable rates. The full text of a Departmental announcement follows:*

The beam stations in Australia are being built in Victoria because the best sites were found there. Although the transmitting apparatus is at Ballan, 50 miles from Melbourne, and the receiving apparatus is at Rockbank, 15 miles from Melbourne, the operators sending and receiving the messages will be located in the wireless company's headquarters at Queen Street, Melbourne.

Messages to and from all parts of the Commonwealth will be concentrated by wire and wireless at this center, and from there they will be dispatched to their various destinations. There will be no relays between Melbourne and London, and it is reported that the signals are so powerful that transmission and reception will be at the rate of over 100 words a minute.

**Will Serve United States**

The beam service between Australia and England will be available for telegrams to and from the United Kingdom and all European countries, and the beam service between Australia and Canada will be used for tele-

grams to and from Canada, the United States and South America.

In Sydney a public accepting office and a central operating room are being prepared for the Amalgamated Wireless Company in their new building, 47 York Street, and the operators will be in direct touch with the Melbourne center, feeder station for sending to Melbourne both by wire and wireless. The wireless will be at the Pennant Hills radio center, and a receiving station is now being constructed near La Perouse, Sydney. The Sydney center will also operate a wireless service to New Caledonia and later with other places in the Pacific Ocean.

**Tests Are Begun**

At the end of December a beginning was made at Ballan of the actual tests of the beam wireless station. The Canadian section of the beam transmitter is not yet complete to facilitate the completion of the stations for communication with Great Britain, as work on the Canadian stations has been partly suspended. Until the stations for working with Great Britain are fully completed, it is not possible to indicate when preliminary tests of the Canadian portion of the beam system will be begun.

However, the station for transmission to Great Britain is daily in communication with the English reciprocal station, and it is stated that the results have been satisfactory so far as they have gone. Further tests have to be made, but it is expected in Australia that the stations for communications between Great Britain and Australia will be opened for commercial use sometime this month.

## Cellist Is Proud Indeed of His Medieval Bow

Misha Gegna, of KNX, Also Has Rare Violin That Possesses Fine Tone Power

**Los Angeles.**

Misha Gegna, cello virtuoso, an exclusive KNX artist, is extremely proud of the cello bow that he now has. Here is something of interest about it.

Francais Tourte was the inventor of the modern bow, early in the nineteenth century. By the excellence of his workmanship and artistic character he brought the art of bow making nearer perfection than any other maker. He was to bows what Antonius Stradivarius (who produced those inimitable instruments which have rendered him so famous) was to the violin. His influence on the development of modern music was very great. The late Theodore Thomas said that without the violin by Stradivarius and the bow as developed by Francais Tourte the symphonies of Mozart, Haydn and Beethoven, with their light and shade, would not have been possible. The cello bow recently purchased by Misha Gegna,

prominent Russian cellist, is a representative example of Tourte's work of 1810-20, and it is in very fine state of preservation. The violin and cello bows of Tourte have distinctive tone-producing power as compared with other bows, that is to say, the Tourte draws a larger and far richer tone from a given instrument than any other bow, new or old. Misha Gegna is to be congratulated on the possession of so rare and valuable a treasure, for it is indeed priceless. Mr. Koodlach and Mr. Pullpenick, well-known violin makers, and Mr. Stewart, who has received praiseworthy comments on his cello work were the judges in Misha Gegna's selection, which was made from a special collection of invaluable and rare bows brought here from New York by the Wurlitzer Company. This bow, together with the Guarnerius cello, gives Misha Gegna precious possessions, as he is well aware.

## A THOUGHT FOR THE WEEK

THEY are now paying promissory notes in London on signatures radioed across the Atlantic from New York City. Now let the fiction writers get busy and tell the world of some exciting and unsavory exploit by a modern Jim the Penman.

# RADIO WORLD

The First and Only National Radio Weekly

Radio World's Slogan: "A radio set for every home."

TELEPHONES: BRYANT 0558, 0559  
 PUBLISHED EVERY WEDNESDAY  
 (Dated Saturday of same week)  
 FROM PUBLICATION OFFICE  
 HENNESSY RADIO PUBLICATION CORPORATION  
 145 WEST 45th STREET, NEW YORK, N. Y.  
 (Just East of Broadway)  
 ROLAND BURKE HENNESSY, President  
 M. B. HENNESSY, Vice-President  
 FRED S. CLARK, Secretary and Manager  
 European Representatives: The International News Co.  
 Breams Bldg., Chancery Lane, London, Eng.  
 Paris, France: Brentano's, 8 Avenue de l'Opera

EDITOR, Roland Burke Hennessy  
 MANAGING EDITOR, Norman Bernard  
 TECHNICAL EDITOR, Lewis Winner  
 ART DIRECTOR, J. Gerard Shedy  
 CONTRIBUTING EDITORS:  
 J. E. Anderson and James H. Carroll

## SUBSCRIPTION RATES

Fifteen cents a copy. \$6.00 a year. \$2.00 for six months. \$1.50 for three months. Add \$1.00 a year extra for foreign postage. Canada, 50 cents.  
 Receipt by new subscribers of the first copy of RADIO WORLD mailed to them after sending in their order is automatic acknowledgment of their subscription order. Changes of address should be received at this office two weeks before date of publication. Always give old address; also state whether subscription is new or a renewal.

## ADVERTISING RATES

General Advertising  
 1 Page, 7 1/2 "x11" 462 lines.....\$300.00  
 1/2 Page, 7 1/2 "x5 1/2" 231 lines..... 150.00  
 1/4 Page, 8 1/2 "x7" 231 lines..... 150.00  
 1/2 Page, 4 1/2 "x7" 115 lines..... 75.00  
 1 Column, 3 1/2 "x11" 154 lines..... 100.00  
 1 Inch..... 10.00  
 Per Ad Line..... .75

Time Discount  
 52 consecutive issues..... 20%  
 26 times consecutively or E. O. W. one year.. 15%  
 4 consecutive issues..... 10%  
 WEEKLY, dated each Saturday, published Wednesday.  
 Advertising forms close Tuesday, eleven days in advance of date of issue.

## CLASSIFIED ADVERTISEMENTS

Ten cents per word. Minimum 10 words. Cash with order. Business Opportunities ten cents per word. \$1.00 minimum.

Entered as second-class matter March 23, 1922, at the Post Office at New York, N. Y., under the Act of March 3, 1879.

## TO WIT:

The radio field needs wit.  
 Here it is.  
 What are we going to do about it?

Our local seat of learning, Helli-nall College, is adding a course in radio to its curriculum. The course costs \$6.90 per term—and furnish your own tubes.

Grandma Betty Glucose says she slept very little before her grandson bought a radio set. Now she doesn't sleep at all.

Our enterprising Chinese laundryman, Charlie Gee Whizz has a new model 5 Near-DX set. The only thing Charlie tries to tune in is static. He says it's just like his native music.

## Broader Program Fields

IT would be well for some great chain, like one managed by the National Broadcasting Company, to canvass the field of moral and intellectual leaders, so that persons seldom, if ever, brought before the microphone would thrill the nation with their pointed pleas and mighty messages.

The general rule of selection of performers is to pick out those with the greatest fame and have them do the things for which they are famous. When dealing with artists who are constantly in the limelight that is easy enough. But suppose that a little pioneering be done?

Let us select a few of our most gifted historians. Suppose one delivers an oral history of the early settlements in America, another the story of the Revolution. For ten minutes each night, two or three nights a week, the history of the United States could absorb listeners for weeks. Nothing else would so quickly inform so many persons of historical facts they know not, or have forgotten. Such enterprise is worthy of a great chain of stations. Spasmodic talks of historians more willing than thrilling hardly fill the desire for constructive broadcasting.

Let us take the story of the creation and growth of world markets, that modern development which antiquated even Washington's advice about "foreign entanglements." Now every country in the world is a part of American territory, commercially speaking, and this development of domestic or local markets into world markets is a drama all by itself, fit for the leading economist to narrate to the radio audience.

Take persons who have overcome great difficulties—fought their way up to success and riches from ignorance, failure and poverty, or like John D. Rockefeller, Jr., who overcame the handicap of great wealth, to become a noted business and moral leader. The microphone has risen to a place of such high esteem that any one should feel honored to be called to deliver into it his code of success, psychology of life or story of struggles.

The whole field of talent is indeed wider than what most of us imagine it to be, at first blush. The routine may have to be upset in the program director's room, harder tasks imposed on him than usual, but bigger things produced than those most widely advertised today.

In other words broadcasting is not a feast of music, in its true aspect, but a means of serious education and information, plus entertainment. Persons of intelligence preponderate in radio audiences, and they look forward with keenness to what intellectual leaders have to say. That programs today are top-heavy with music is obvious.

Take as an example of moral leadership—Helen Keller. Her great soul is filled with the finest sentiments, and millions would be only too glad to hear her often. They know how she overcame constitutional handicaps most amazingly. They may not know, but would find out soon enough, that, like Abraham Lincoln, she has the gift of penetrating the hearts of people in few words. For instance, she is a lover of dogs, and recently was photographed with her Great Dane, Sieglinde. On being complimented, by "The National Humane Review," for not having had the dog's ears cropped, she responded:

"I should indeed be happy if the picture might induce even one person to refrain from cropping his dog's ears. The practice seems to me cruel and stupid. Whenever I touch a mutilated animal, I am filled with pangs, and I yearn to show people how barbarous the custom is. I pity the man who has something—or lacks something in his make-up—that prompts him to inflict torture upon a living creature. I can hardly believe that a man of spirit would pinion between his knees the head of a dog whose little heart beats

with love for him—a friend who rejoices when he comes and grieves when he departs, and lop off the tender ears that quivered with joyous emotion when he approached!"

The jazz orchestra might step aside for five minutes a week to give Miss Keller the right of way.

## Talks Popular Again

TALKS have gone up and down on the popularity curve. When broadcasting was in its cradle there were talks aplenty, for it was largely a choice between any kind of a talk and some indifferent musical performance. Since then great musical concerts have graced the microphone quite often, the jazz orchestras are better, symphonic ones are more numerous than ever, and receptionists prefer higher to lower music. Also, talks are on a higher plane. Listeners tune them in with eagerness, instead of tuning them out with vengeance. The reason is that program directors have made a study of what type of talks interest listeners. The variety is wide, indeed, but whatever the theme, the subject matter must be authoritative, or listeners soon tire of it.

## Less Broadcasting Is Crosley's Advice

Cincinnati.

Powel Crosley, Jr., said:

"We need less broadcasting. We need good broadcasting. We do not need poor or mediocre broadcasting. The law of the survival of the fittest must apply to broadcasting stations. The commission should fearlessly eliminate unnecessary broadcasting to make room for the better type of stations.

"The fear of a broadcasting monopoly has long since passed. The argument of monopoly is presented by mediocre stations in order to retain their unexcused existence. The public interest is first and foremost and in the end it must be served. The American public generally gets what it wants."

## Time to Chime Fine By New Time Chime

A new device originated by Hugo Gernsback, which he terms the "Time Chime," will be in operation at WRNY very shortly. The Time Chime is an electrical device hooked up with the Western Union Time Service, whereby, at the stroke of every hour, a chime will be sounded automatically by electrical means and be transmitted via WRNY. A few seconds before the chime is put on the air the announcer will give the warning to stand by for a few seconds to receive the exact time. It is thought that it is the first time that an hourly time service has been given to listeners by any broadcast station. The service, of course, is given only while the station is on the air.

## Speaker Put on Ice

So many other things are served "on ice" that it is not surprising that radio broadcasting has finally crashed its way into this charmed circle. WEAf, recently received a letter from Ontario which revealed how broadcasting was a great aid in making a skating party more merry. A radio loudspeaker was connected and placed outside on the ice. This group of Winter sports lovers danced upon the ice to the tunes of the Ipana Troubadours and the La France Orchestra and many others whose music goes out on WEAf's wave.

# Highest Acoustical Order Rules Roxy Broadcasting

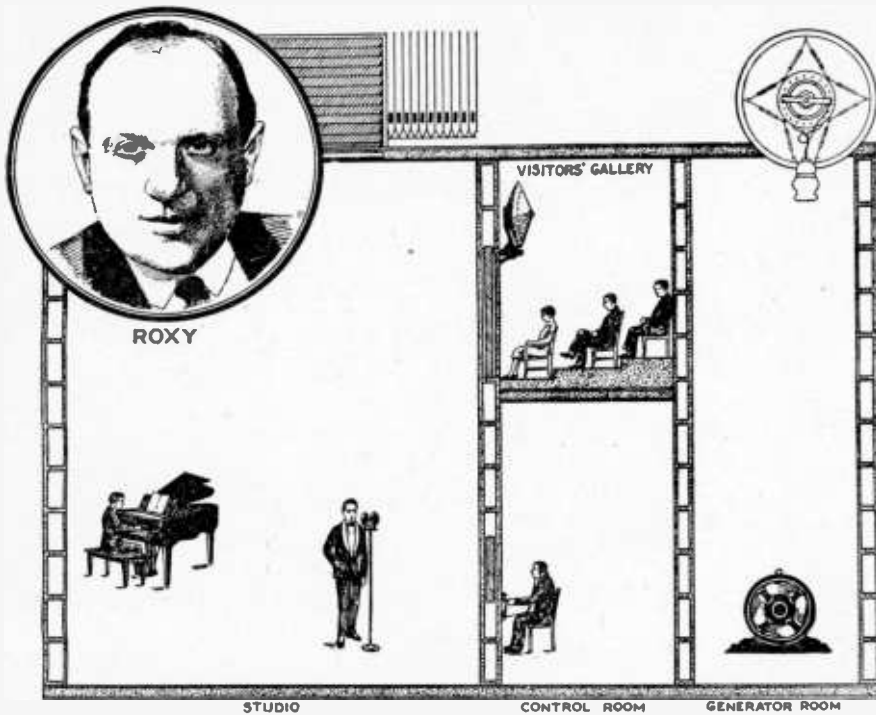

A CROSS-SECTION view of the broadcasting rooms of the Roxy Theatre, including the studio, the control room, the battery and generator room and the visitors' gallery. Above the studio is a specially designed organ used for broadcasting only, with an arrangement of shutters which allows the organ loft to be shut off from the studio when the organ is not in use.

## Studio in His New Theatre Represents Latest Advances in the Arts Entering Into Its Making, Even To the Angle of the Corners

The new Roxy Theatre, New York City, the largest in the world, has a special broadcasting studio in the theatre, from which Roxy and his Gang are heard every Monday evening through WJZ and the associated stations of the National Broadcasting Company's Blue Network, WBZ, KDKA, KYW, WRC, WHAS, WSM and WSB. In design, in acoustical properties, in construction and in operating convenience, this studio represents the latest advances in every art which has entered into its making.

In the first place, the studio is situated on the fifth floor of the theatre building, far enough above the street level to insure that traffic and sidewalk noises will not affect the most sensitive microphone pick-up. The walls, the floor and the ceiling have received special treatment which makes them contribute their share to the fine tonal values of the studio.

### A Special Studio

The studio is one of the few which have been planned and constructed especially for broadcasting purposes. The exact plans and specifications of the studio, control room, generator and visitor's gallery were laid out in detail by broadcasting engineers working in conjunction with architects familiar with this phase of construction. When the plans for the Roxy Theatre were being drawn, ample space was left for the broadcasting plant, and members of the Operations and Engineering Department of the National Broadcasting Company, under the supervision of O. B. Hanson, manager of the department, worked out the details of the various rooms and dictated the specifications. The wisdom of this course is apparent.

Instead of having to do the best they could under pre-arranged conditions, which might or might not have been favorable, the engineers were able to design a studio with as nearly perfect acoustical properties as modern experimentation in the study of sound and echoes can yet produce and a system of control apparatus for relaying the program to the broadcasting station which is a model of convenience and efficiency.

A cross-section view of the broadcasting rooms in the theatre reveals that the studio proper is twice the height of the control room and the visitors' gallery. The studio is constructed without pillars or breaks in the wall surfaces which might destroy its acoustical properties. Every corner of the room, including corners between the side walls and the ceiling, is a 90-degree angle.

### Shaft Runs to Organ

Through the middle of the ceiling, a square shaft runs to the organ loft, which contains a specially designed organ used for broadcasting only. Above the surface of the studio ceiling, in the loft, the four walls of this shaft consist of shutters, any of which can be opened to any degree, controlling the volume of the organ music which can enter the studio and the microphone, as well as allowing emphasis to be placed upon any desired passage of the music. The organ is operated from a manual in the studio directly beneath the loft.

At regular intervals around the walls of the studio are microphone outlets connected with the control board. Since many different kinds of music are to be broadcast from the studio, including the

work of a large chorus, many more microphone outlets have been provided than in most remote-control studios.

Special lighting arrangements have been made, with the view of illuminating every portion of the studio without producing any objectionable glare. The latest system of ventilation, including a pumping system which provides fresh air and a cooling system, will enable the artists to work the year 'round, a condition possible in few broadcasting studios.

In the wall beside the studio entrance is a plate glass panel, situated at eye-level of a person seated in a chair, and just below this panel, the control apparatus has been installed. The control operator sits facing the studio, and every performer is within his vision at all times. The placement of the apparatus is such that, once an operator has become familiar with the controls, he can make all necessary adjustments without taking his eyes from the artists who are broadcasting.

### Sound Proof Control Room

The control room has been specially sound-proofed so that the operator and members of the theatre's musical staff may be able to judge the balance of the music by listening to it from a loud speaker connected with the control panel. This method of insuring proper balance and volume by testing a "sample" of the broadcast exactly as it will be heard in listeners' homes has been found more satisfactory than gauging the quality of the music by means of headphones.

A sound-proof booth provided with one door opening into the studio and another opening into the control room enables members of the musical staff to pass from one room to the other without allowing sounds to accompany them. A complete system of signal lights allow the operator to communicate with the studio without leaving the control panel.

These facts and the additional one that an assistant conductor of the theatre is always present at the control panel with him enable the operator to forecast changes in volume, shifting of microphones and other changes for which he must make allowance. The assistant conductor at the panel is equipped with a complete musical score of the broadcast and he has attended at least one rehearsal of the entire broadcasting period, as is customary with other National Broadcasting Company features. Consequently, the operator is advised of approaching changes before they become necessary. This system makes for a much more smoothly running program, one without awkward pauses and one during which changes in volume are made so gradually that the average radio listener can scarcely notice them.

### Battery and Generator Room

Directly in the rear of the control room is the battery and generator room, where the program is fed into the special circuit connecting the studio and the control apparatus of WJZ at Aeolian Hall, from which point the music and speech are carried by other special circuits to the station's transmitter at Bound Brook, N. J., and also to the Bell System Long Distance Headquarters at 24 Walker Street for distribution to the other stations of the National Broadcasting Company's Blue Network.

Above the control room is the visitors' gallery. A large plate glass window allows visitors to watch the broadcasting in the studio, and the floor is laid at three different levels so that every visitor may obtain an unobstructed view of the proceedings. At the same time, through a loud speaker connected with the control panel, the audience which is looking on can hear the music as it starts on its travels over the eastern half of the United States.



# Radio University

A FREE Question and Answer Department conducted by RADIO WORLD for its yearly subscribers only, by its staff of Experts. Address: Radio University, RADIO WORLD, 145 West 45th St., New York City.

When writing for information give your Radio University subscription number.

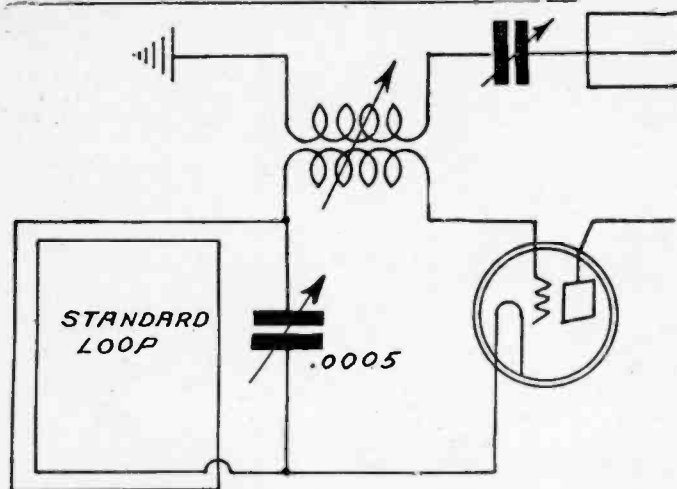

FIG. 528

The circuit diagram illustrating a trap system, which works very efficiently with receivers that are very close to broadcasting stations.

I HAVE a six-tube receiver, wherein three stages of untuned radio frequency amplification, a regenerative detector, using a three circuit tuner and two stages of transformer audio frequency amplification are employed. I live about six blocks away from a newly installed 500-watt station, which naturally is giving me some trouble. An antenna is now used, although there is provision in the set for a loop which I use, but without success. That is, it does not even help me tune this station out completely. I have on hand two .0005 mfd. variable condensers. Could these be employed in any way in a trapping scheme, for tuning out this station, as well as several others, which are quite near and give me some trouble?—James F. Sceller, Bridgeport, Conn.

Such a scheme is outlined in Fig. 528. You will note that both the antenna and the loop are used, the .0005 mfd. variable condensers tuning the loop circuit and the antenna. The antenna is inductively coupled to the loop circuit, via a coil which has a variable and stationary form. The stationary form is in the antenna circuit, while the rotor is in the grid circuit. The stationary winding consists of 65 turns, wound on a three-inch diameter form. The rotor contains ten turns, wound on two and one-half inch diameter form. No. 24 double cotton covered wire is used throughout on both windings. The untuned RF transformer in the first stage, you will note, is taken out. If the filament of this tube is controlled by a ballast resistor, or a rheostat used to control the filaments of some other RF or audio tube, disconnect it and connect in a separate rheostat of the twenty-ohm type in series with the negative leg of the filament. No other changes need be made. The loop is turned to the direction where the station's signals will have the least intensity. The loop condenser is then used to aid this condition. Then the antenna condenser is used to tune the station out. The rotary coil completely tunes the station out.

In other words, both circuits are tuned to resonance to tune out the station, aided by the rotary coil. The B battery voltage should be no greater than sixty-seven and one-half volts. It will be found that the filament adjustment will also aid in tuning out the signal.

REFERRING TO the five-tube receiver which appeared in the Dec. 11 issue

of Radio World on page 12, under the resistor article. (1)—Could radio frequency transformers having ten turn primaries and seventy turn secondaries, wound on a two and three-quarter inch diameter tubing, wound with No. 22 double cotton covered wire, with a quarter inch space between the two windings, be used? (2)—What is the capacity of the variable condensers that should be used with these coils? (3)—Would I get satisfactory results if I used a twenty ohm rheostat for the detector filament; a 112 Amperite for the two audio frequency and another 112 for the last audio frequency tubes? The filaments are wired in that manner in a resistance couple amplifier that I have. (4)—The B plus leads from the first two audio tubes are connected together, while the last audio plate is connected to another B lead. C battery provisions are made for the two first grid circuits, as well as for the last grid circuit. Is this O. K.? (5)—Is it necessary to insert a filament switch? Where?—George Franklin, Woodside, L. I., N. Y.

Yes. (2)—Condensers having capacities of .00035 mfd. should be used. (3)—Yes. (4)—Yes. (5)—Yes. In series with either the plus or minus A battery leads.

I HAVE a three-tube, three-circuit tuner receiver. Transformer audio frequency coupling is used. Recently, I tested the milliampere drainage and obtained the following results with the following tubes:—using a —01A tube in the detector circuit, with forty-five volts on the plate, the drain was 2.5 milliamperes; using a —01A tube in the first AF stage, with ninety volts plate and four and one-half volt C bias, the drain was 1.95; using a 112 tube in the last AF stage, with 135 volts plate and seven and one-half volts C bias, the drain was 9.1 milliamperes. The total drain was 13.55 milliamperes. Are these about the correct values that should be obtained?—William S. Mulroom, Lexington, Ky.

Yes.

IN THE Feb. 26 issue of Radio World on page 11 there appeared an electrical diagram of a three-tube regenerative receiver, using a variometer in the detector plate circuit. Now I have had a set of this type for quite a long time, and have received good results with it. However, there is one fault that I have had, and that is it is pretty difficult to make the detector tube oscillate above 450 meters.

I tried increasing the plate voltage, but that made the tube control very erratic. The variometer that I am now using is a small one. I have a larger one and thought that by inserting this one, the results would be better. Is this true? (2)—Could I add another stage of radio frequency amplification to this receiver? (3)—The coil I am now using contains a fifteen turn primary and a fifty turn secondary wound on a three-inch diameter tubing with No. 24 double silk covered wire. Should the new coil be wound with the same number of turns, same wire and on the same tubing as this one? (4)—How should it be connected?—Everett Davidson, Kansas City, Kans.

(1)—If this larger variometer actually has a greater inductance value, and is not just physically larger with compensation in the number of turns in comparison to the smaller, then use it. Otherwise, you will receive the same results. This fact can easily be known if the number of turns on the smaller one are counted, and then the number of turns on the larger one are counted. If you find that the larger one has a smaller number of turns, then you can rest assured that only compensation for a larger form was made and that the inductance is no greater than that of the smaller. If this is the case, try placing a .0005 or even .001 mfd. fixed condenser across the variometer. Also try increasing the resistance of the grid leak. (2)—Yes. (3)—Yes. (4)—The beginning of the primary winding should be brought to the antenna binding post. The end of this winding should be brought to the ground binding post. Now the beginning of the secondary winding, which is right next to the end of the primary winding, is brought to the minus A binding post and to the rotary plate post of a .0005 mfd. variable condenser. The other terminal of the secondary winding is brought to the grid post of the new socket and to the stationary plate post of the .0005 mfd. variable condenser. The plate post on this socket is brought to the beginning of the primary winding of the coil you now have in the set. The end of this winding is brought to the B plus sixty-seven and one-half volt post. Both these terminals originally went to the antenna and ground, respectively. A twenty-ohm rheostat is connected in series with the negative filament post. The plus F post of this socket is brought to one terminal of the switch S, the other terminal of which is connected to the plus A post.

ON PAGE 10 of the March 12 issue of Radio World there appeared a circuit diagram of six-tube receiver, which attracted my attention. (1)—Will I receive good results if I use —01A tubes throughout the set? (2)—Could I use 1A Amperites in all the filament circuits? (3)—What is P? (4)—Is R a twenty-five ohm rheostat? (5)—Is the C bias on the last AF tube 405 volts, or is this an error? (6) Could I connect a 500,000 ohm variable resistance across the secondary of the first audio transformer for volume control?—Alfred Abrahms, Kingston, N. Y.

(1)—Yes. (2)—Yes. (3)—P is a small pilot light, used to indicate when the filaments are on or off. (4)—Yes. (5)—This should read 40.5 volts, and is the C bias for the —71 tube, using 180 volts B, should this power tube be used. It is not absolutely necessary to use this power tube. (6)—Yes.

I HAVE built a two-tube receiver, using a regenerative radio frequency amplifier (three-circuit tuner scheme), a crystal as a detector, and a stage of transformer audio frequency amplification. The filament of the audio tube is controlled by a ten-ohm rheostat. I intend adding a step of transformer audio coupling. Could I use a 6-ohm rheostat to control the filament of both tubes used



in this circuit, both being of the -01A type? (2)—I find that my set is too sharp. This, I think, is due to the use of the extremely short antenna. Could this be cured by adding turns to the primary of the tuner? At present it consists of eight turns.—Julian Thomas, San Diego, Calif.

(1)—Yes. Be sure that the wire can carry three-quarters of an ampere, at least. (2)—Add about seven turns.

A RECENT cleaning up of my workshop disclosed that I had several four to one ratio audio transformers; two .0005 mfd. variable condensers; a three-circuit tuner and a tuned radio frequency transformer, both of which are for use with .0005 mfd. condensers, and three type X sockets. I would like to use these parts to construct the circuit shown in the Radio University columns of the Aug. 21 issue of Radio World on page 12. Could I use the extra two audio transformers for two more stages of AF amplification, giving me three stages? (2)—Will I get good results, using this four to one transformer in the reflex stage? (3)—Could I leave SCJ out? (4)—How should I control the filaments of the audio tubes?—F. James Mard, Albany, N. Y.

(1)—No. You will receive a great deal of distortion. Two stages of transformer coupling will give you plenty of volume. (2)—Yes. (3)—Yes. (4)—Use ballast resistors to control the audio filaments. The filament of the radio frequency amplifier should be controlled by a twenty-ohm rheostat.

I HAVE a five-tube receiver, in which two stages of tuned impedance radio frequency coupling, a non-regenerative detector and two stages of transformer coupling are employed. The wiring is very similar to that shown in the Radio University columns of the Feb. 12 issue of Radio World, except that there is no variable condenser in the antenna circuit. Now I would like to rebuild this set, so that I only have a two major control set, with a rheostat for the RF filament and for the detectors only. That means that the AF filament rheostat and the potentiometer (which I find to be unnecessary, since I have to keep it all the way over to the minus A side, anyway), will have to be taken out of the circuit. Is this O. K.? (2)—Will the elimination of the double circuit jack at the detector output decrease the efficiency of the receiver? (3)—I intend placing the complete set in a twenty-four inch long cabinet. Will this be all right?—Edward Macks, Peekskill, N. Y.

(1)—It is not practical to use a double condenser, which would be necessary in this type of receiver. The potentiometer may be left out, as well as the rheostat on the AF tubes. Ballast resistors, type depending upon tubes used, may be used to control the filament of each tube. (2)—No. (3)—Yes. Place the coils in back of the variable condensers which are equally spaced along the panel.

IF IT is 9 p. m. in Chicago, what time is it in N. Y. City? (2)—If it is 11 p. m. in N. Y. City, what time is it in San Francisco? (3)—How many time zones are there in the U. S.?—Arthur Levis, Hollywood, Fla.

(1)—10 p. m. (2)—8 p. m. (3)—Four sections, e.g., Pacific Time, Mountain Time, Central Time and Eastern Time.

PLEASE GIVE me the circuit diagram of a B eliminator, using the following parts, which I have just been presented with:—a transformer to be used on the 110.60 cycle line, having a secondary which is tapped and giving 220 volts on each half; a pair of two, one and a single eight mfd. fixed condensers; three Clarostats; two thirty henry chokes, and a Raytheon tube (old model). I am told that the

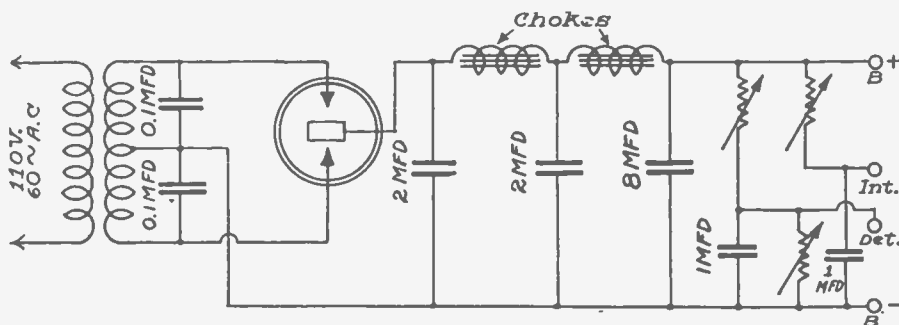

FIG. 529  
The circuit diagram of the B eliminator requested by Harriss Marks.

transformer was designed for the old model tube.—Harriss Marks, Leonia, N. J.

The circuit diagram of such an eliminator is shown in Fig. 529. The variable resistances are indicated by the zig-zag lines, with the arrow running through them from the main B plus lead. You will need two .1 mfd. fixed condensers. These are known as buffer condensers and are used to balance the input line. Each of items you have are labelled in the diagram.

ABOUT THREE months ago, I purchased a five-tube receiver of the reflexed type. The results were great until recently, when moving the set about, I broke several connections. I cannot find out where the broken wires are connected to, and am, therefore without a workable set. Upon looking over the interior of the set, it seems as if there are two tuned radio frequency stages, a detector, with a tuned transformer, and two stages of transformer AF. There are also four audio transformers; three rheostats which light up the radio frequency and detector tubes, and a switch which turns off all the lights at once. Have you ever published a diagram of a receiver similar to this, giving the constants of the parts, etc? The following are the markings on the binding posts: C minus; A minus; A plus; B minus; B plus 1; B plus 2, and B plus 3. Binding posts are used for connecting up the loud speaker.—Jerome Grand, Ypsilanti, Mich

In the Radio University columns of the Oct. 16 issue of Radio World, on page 14, there appeared a circuit diagram with a complete description of a receiver similar to the one you describe.

I WOULD like to add a two stage resistance coupled audio frequency amplifier to a receiver which now employs two stages of tuned radio frequency amplification, a regenerative detector using a three-circuit tuner and one stage of transformer AF amplification. Three .0005 mfd. variable condensers are em-

ployed. A single winding inductance is used in the antenna circuit, e.g., fifty-five turns wound on a three inch diameter tubing using No. 22 double cotton covered wire and tapped at the fifteenth turn, this tap being brought to the antenna. The primary and secondary windings of the TRFT and the tuner are the same, e. g., ten turn primaries and forty-five turn secondaries, wound on three inch diameter tubings with No. 22 dcc wire with no spacing between windings. The filaments of the RF and detector tubes are each controlled by fifteen ohm rheostats. The audio filament is controlled by a 1A Anperite. A four and one half C bias is used here with ninety volts B. The filaments are all turned off with a switch. The amplifier I have is a manufactured unit with separate C bias and B voltage leads for each tube. The type X sockets are used. There is no external filament control, ballast resistors being used. The words, "use a 1/2 ampere power tube here," appear under the last socket. I therefore intend using a -01A tube in the first of these stages and a 112 in the last stage. Will I get good results?—John Alsteader, Zion, Ill.

This unit will work all right. Use one hundred thirty-five volts B on the -01A tube in the first resistance stage and one hundred fifty-seven, and one-half volts B on the 112. Use a nine volt C for the -01A and ten and one-half C bias for the 112. The one hundred thirty-five volts B can also be used on the plate of the 112 tube. In this case, reduce the C voltage to nine.

IS THERE a broadcasting station in Haiti? (2)—What wavelength is used? (3)—How much power is used? (4)—Exactly where are they located? (5)—Who is the station controlled by?—Kenneth Steamer, Boca Raton, Fla.

(1)—Yes. (2)—361.2 meters. (3)—According to the last report we have they use 1,000 watts. (4)—Port Au Prince. (5)—By the Haitian Government.

## Join RADIO WORLD'S University Club

And Get Free Question and Answer Service for the Coming 52 Weeks  
This Service for Yearly Subscribers Only

Have your name entered on our subscription and University lists by special number. Put this number on the outside of the forwarding envelope (not the enclosed return envelope) and also put at the head of your queries. If already a subscriber, send \$6 for renewal from close of present subscription and your name will be entered in Radio University. No other premium given with this offer.

[In sending in your queries to the University Department please paragraph them so that the reply can be written under or alongside of each query. Write on one side of sheet only. Always give your university number.]

RADIO WORLD, 145 West 45th Street, New York City.

Enclosed find \$6.00 for RADIO WORLD for one year (52 nos.) and also enter my name on the list of members of RADIO WORLD'S University Club, which gives me free information in your Radio University Department for 52 ensuing weeks, and send me my number indicating membership.

Name .....

Street .....

City and State .....

# THE RADIO TRADE

## Industry Draws Heavily On Earth's Resources

Metals Freely Used, While Trees and Silkworms Add  
Their Valuable Contribution to the Vast and  
Varied Demands of the Art

By Frank A. D. Andrea

Not the least of radio's service to mankind is the utilization of vast quantities of the world's raw materials, metalliferous minerals, refined products of the foundries, a varied output of the machine shops and a hundred and one specialized essentials of the finished apparatus. From a simple piece of paper to platinum, from the woods of our forests to the finest chrome steel, radio well nigh runs the gamut in scope of substances used in its manufacture.

To tell the whole story of what goes into radio making, starting with the early day when scarcely more than a crystal made up a receiving set and detail the intricacies of present day production, would fill a volume of interesting information.

### The Highlights

Merely as a thought-provoking commentary on the vastness of the industry in this respect, I shall give here just the highlights of materials used in a modern factory where receivers and speakers are manufactured and where in tests other radio apparatus is in constant use.

Silver is used for contact points. Silver

plating is utilized on stranded copper wiring to make it a better conductor of electricity.

Platinum is found in lead-in wires in tubes and as contact points on vibrating chargers.

### Radio Uses of Paper

Many are the uses of paper in radio. For the cones of cone speakers in the best outfits a book cover paper specially designed for radio is used. This particular paper has no definite "grain," the fibres being all broken up by water shower process to keep from forming a definite grain, to better control the sound. Corrugated paper is used for cartons, wax paper for wrapping sets, good old-fashioned brown, or wrapping paper, for many purposes. There are paper gaskets for cones underneath the screen ring that frames the screen, on cone speakers.

In 1927 model sets paper is utilized in connection with the tuning scales. Here a coated stock appears underneath the celluloid—which gives another item to check, namely celluloid, which as most of the school children know, if not grownups, is a compound of camphor and gun-cotton;

in fixed condensers, by the way, a very special insulating paper is set between each layer of tin foil.

### Enter Chemical Terms

Chromium, vanadium and many other words not used in every-day conversation find their way into any study of what goes into radio.

Chrome steel is the product out of which magnets for the fine loud speakers are made. This is a special process steel. Vanadium also is utilized in magnet building.

A single sentence descriptive of the inner workings of a modern speaker takes in several materials and is loaded with suggestions of intricate design:

"From the chrome steel-hardened main magnet through the special bakelite bobbins carrying the hair-fine wire coils, to the specially fitted pole pieces and the minute but carefully balanced armature with its phosphur-bronze 'retent,' down through the actuating pin with its carefully calibrated reducing motion," etc. etc.

### The Silk Worm Helps

In far-off China the silk worm labors for radio, too. Silk is used in radio as a covering for various kinds of magnets and connection wires, as a covering for "telephone" or headpiece cords, as a covering for loop wire and for inductance coil covering.

The backs of certain loudspeakers utilize silk cloth as a protective measure to keep dust, etc., out of the apparatus. Silk braiding is used also around the edges of cones.

Gun-cotton, in addition to basic use given above, is used in the making of lacquer for finishing cabinets. Cone speaker bases, chassis of fine sets, etc., are sprayed in this manner. Into the cleaning process goes carbon tetra-chloride.

Silicon answers radio's call in the making of special steel from which transformer laminations are punched. Silicon is used a great deal for electrical purposes, and  
(Concluded on page 23)

## WORLD'S FINEST LOUD SPEAKER ~ ~ GENUINE ~ ~ "ENSCO" 3' CONE KIT

ONLY \$10  
Can be Assembled  
in Less Than an  
- HOUR -

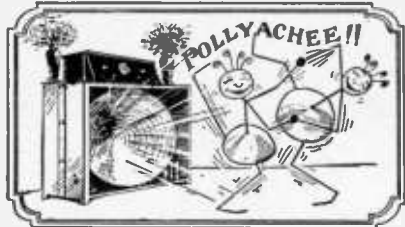

ONLY \$10  
The Original Three Foot  
Cone Speaker  
- KIT -

**NO DISTORTION**      **THE SOLUTION OF THE LOUD-SPEAKER PROBLEM**      **PERFECT FIDELITY**  
*The Choice of Leading Engineers*

COMPLETE parts furnished in kit form.

We guarantee this speaker the equal of any manufactured cone speaker at any price. With this **THREE-FOOT CONE SPEAKER** you hear all the tones. It brings out the true depth and beauty of orchestral and instrumental music. Can be operated softly for living room music or full volume for dancing, and without trace of distortion. Kit includes famous "ENSCO" cone unit, the only direct-

drive, distortionless unit for large cones; Alhambra Fonotex for big cone, with brass apex, two sopro prints showing cabinet or stand construction for cone speaker, also wall and roll types. All necessary instructions.

Buy this wonderful speaker under our absolute guarantee. Your money back if you are not convinced that it is the finest reproducing medium obtainable at any price. It works on any set, with ordinary Tubes or with Power Output.

When in New York City visit Studio and listen to Demonstration of the  
**WORLD'S FINEST LOUD SPEAKER**  
ENGINEERS' SERVICE CO., 25 Church Street, New York City

**SEND NO MONEY!**

Write your name plainly as indicated below, then mail and complete kit will be forwarded to you. Just pay postman \$10.00 upon delivery.

Name .....  
Address .....  
City and State.....  
ENGINEERS' SERVICE CO., 25 Church Street (Desk W), New York City

### WATCH EXPIRATION OF YOUR SUBSCRIPTION!

Subscribers will note that the end of their subscriptions is indicated on the labels on wrappers. If your wrapper shows a date earlier than the current issue, please send payment for renewal. Changes in expiration dates on wrappers appear two weeks after receipt of renewal.

RADIO WORLD, 145 West 45th St., New York City. (Phones: Bryant 0558-0559.)

BUY  
**NATIONAL**  
RADIO PRODUCTS  
For  
Satisfactory and Lasting Results  
**NATIONAL COMPANY, INC.,**  
Engineers and Manufacturers  
W. A. READY, Pres., Cambridge, Mass.

**FREE!!**

OUR NEW FREE

**Radio Catalog**  
Will Save You Money



Before you build or buy a radio be sure to consult our new 100 page catalog — sent to you free. All the latest kits, accessories, and parts — a million dollar radio stock to choose from.

### Save Money

We handle only brand new apparatus — standard makes that are fully guaranteed.

QUANTITY sale of QUALITY parts explains our new low prices. Compare with others and see why thousands of fans look to us as radio headquarters.

Write for your copy of this new catalog today.

**Chicago Salvage Stock Store**

Dept. RW, 500 S. State St., Chicago, U. S. A.

(Concluded from page 22)  
goes into the steel for pole pieces and armatures in certain cone speakers.

**Bakelite's Thousand Purposes**

Bakelite is said to be the material of a thousand uses. I shall not detail all of them here. But in radio Bakelite is used for: panels for receivers, for sockets, for rheostats, switch bases, dials, knobs, and many other purposes such as tubing for inductance coils etc., etc., etc.

The Bakelite Corporation describes Bakelite as follows: "When the two-well-known liquids phenol (carbolic acid) and formaldehyde, are made to unite chemically with each other they produce a transparent, amber-like substance, without taste or odor and possessing entirely new chemical and physical properties. From this substance all other Bakelite products are made, such as molding materials, cements, enamels, lacquers, varnishes transparent goods and laminated sheets, tubes and rods." Bakelite's story alone would fill a few books—and, in fact, has already done so.

So that when one refers to Bakelite panels and the other utilizations of Bakelite in radio, it is more correct to say Bakelite laminated panels, dials and knobs made of Bakelite material, Bakelite molded plugs, rheostats, tube bases, etc., for in these designations are contained a more exacting description of the manner in which Bakelite is utilized.

**The Forests Play Their Part**

Even to the most casual non-owner of a radio set—and they are getting fewer each day!—the use of wood in radio is apparent. The cabinets, of course, are of wood, both the average models and the finest art furniture consoles. Walnut, our own American walnut, is a big factor today in radio, and mahogany plays an important part, too, and, of course, there are variations as to the kinds and qualities of woods.

Wood is used also in knobs for tuning purposes, the carved wooden knobs of radio receivers.

Wood is used in making of loops for loop-operated receivers. For this use walnut is the principal wood utilized.

**Copper, Brass, Bronze, Aluminum**

Much has been written of the use of copper in radio. Copper is, of course, used in wiring. It can also be utilized for shielding, for the building of the "cans" as the shielding of the various stages has come to be familiarly called. This is not the only material used in shielding, however.

Brass is greatly used in radio. For variable condenser plates, for nuts, screws, eyelets, rivets, pins, screw machine parts of various sorts, and there are special nuts, special bushings, all of brass, used in shielding work, there are punch press parts of brass, stampings of brass, etc., etc.

Bronze may be called an ornamental aspect of radio receivers although, of course, it has a utilitarian place also. Front panels of late models show the escutcheons etched in bronze. These are set on to the wooden part of the front panels. There are, too, punch press parts of bronze—contact springs for switches and rheostats.

Aluminum is used for the die cast aluminum brackets, for punched press parts for condenser plates. Some of the brackets in cone speakers are aluminum and also some of the moving parts in certain cone speakers, where the element of lightness is necessary.

Leatheroid is frequently used as connector straps for loops, and one of its principal ingredients is gun cotton. Leatheroid, incidentally, is also used for cone supporting discs.

**Rubber, Fibre, Ink, Zinc, Felt**

Rubber is used for covering wire for insulating purposes. Rubber as a dielectric

**NOT A LOT O' SPACE**



**DUE TO oversubscription for space for the Radio Manufacturers Trade Show, to be held in Chicago the week of June 13, space allotments were drawn.**

for radio purposes is an established institution—or material. Here again is a story unto itself which one cannot pause to tell now. What is known as soft, or "live" rubber is made use of extensively.

Fibre is brought into play for various punch press parts and insulating bushings. Ink makes the dial markings on modern sets possible, and is used in connection with the decorations which are in certain cone speakers of a lithographic effect, necessitating utilization of inks.

Zinc in various die castings, such as die cast brackets, cone bases, etc., and felt washers for the feet of cabinets, while not exhausting the materials, brings me near to the end of this story.

To go back a moment. Brass is also used in the hardware for art furniture models, and for knobs and hinges, too. Silk, or rayon, for grills of some of the art furniture models of receivers.

*Greatest Issue of the Year*

**RADIO WORLD'S**

**Fifth Anniversary Number**

**Dated April 2nd.**

**Editorial Features**

"An AC Power Plant," by Lewis Winner. How to build a B eliminator, with one stage of double impedance audio, this tube heated by AC. The A supply is a trickle charger and storage battery.

"Facts Every Radio Experimenter Should Know," by J. E. Anderson. You can derive a great deal more fun building sets and testing them when you are equipped with the information contained in this article.

"A Two-Stage Resistance Coupled Audio Amplifier—and Plenty of Volume," by Herman Bernard.

"A Fine Portable Set," by Jasper Henry.

**Advertiser's Note**

Radio World's Anniversary Number is advertised to hundreds of thousands in other publications, is given special newsstand display, and therefore has an extra circulation of many thousands.

Advertising rates remain the same: 1 page, \$300; 1/2 page, \$150; 1/4 page, \$75; inch, \$10.

Last advertising forms close March 23d, noon. For special position wire reservation collect.

**Radio World, 145 West 45th Street, New York**

**Telephones: Bryant 0558-0559**

## Good Back Numbers of RADIO WORLD

The following illustrated articles have appeared in recent issues of RADIO WORLD: 1926:

- June 18—Selectivity's Amazing Coll. by J. E. Anderson. The Light 5-Tube Portable Set, by Herman Bernard.
- July 3—Set with a J-Turn Primary, by Herman Bernard. Part 2 of the Victoreen Portable, by H. Bernard. Trouble Shooting Article for The Light 5-Tube Portable.
- July 10—A Rub in Single Control, by Herman Bernard. A DX Double Regenerator, by Capt. P. V. O'Rourke. A 2-Tube Dry Cell Receiver, by Samuel Schmalz.
- July 31—What's Best in an AF Amplifier, by Herman Bernard. A 6-Tube Reversed Feedback Set, by K. B. Humphrey.
- Aug. 14—The Improved Browning-Drake, by Herman Bernard (Part 1). Storage Batteries, by John A. White.
- Aug. 21—A New Stabilized Circuit, by E. H. Loftin and S. Y. White (Part 1). The Browning-Drake by Herman Bernard (Part 3).
- Aug. 28—The Constant Coupling, by E. H. Loftin and S. Y. White (Part 2). The Browning-Drake, by Herman Bernard (Part 3).
- Sept. 4—The Four Rectifier Types, by K. B. Humphrey. A Simple Battery Charger, by J. E. Anderson.
- Sept. 11—The Beacon (3-tubes), by James H. Carroll. The 1927 Model Victoreen, by Herman Bernard.
- Sept. 18—The 1927 Victoreen, by Arthur H. Lynch. Eliminator in a Cash Box, by Paul R. Fernald.
- Sept. 25—The Lynch Lamp Socket Amplifier, by Arthur H. Lynch. Wiring up the Victoreen, by Herman Bernard.
- Oct. 2—The Victoreen (Continued), by Herman Bernard. New Equamatic System, by Capt. P. V. O'Rourke.
- Oct. 9—A Practical "A" Eliminator, by Arthur H. Lynch. Building the Equamatic, by Capt. P. V. O'Rourke.
- Oct. 16—The Bernard, by Herman Bernard. How to Box an "A" Supply, by Herbert E. Hayden.
- Oct. 23—The 5-tube P. C. Samson, by Capt. P. V. O'Rourke. Getting DX on the Bernard, by Lewis Winner.
- Oct. 30—The Sinkistrol Receiver, by Herbert E. Hayden. How to Get Rid of Squeals, by Herman Bernard.
- Nov. 6—Reduction of Interference, by A. N. Goldsmith. Variations of Impedances, by J. E. Anderson.
- Nov. 13—The 4-tube Hi-Power Set, by Herbert E. Hayden. A Study of Eliminators, by Herman Bernard.
- Nov. 20—Vital Pointers About Tubes, by Capt. P. V. O'Rourke. The 4-tube Diamond of the air, by Herman Bernard.
- Nov. 27—The Antennaloss Receiver, by Dr. Louis B. Bian (Part 1). Short Waves Yield Secrets, by M. L. Prescott.
- Dec. 4—The Regenerative 5-Tube Set, by Capt. P. V. O'Rourke. The 8-tube Lincoln Super, by Sidney Stack. The Antennaloss Receiver, by Dr. Louis B. Bian (Part 2). Winner's DC Eliminator, by Lewis Winner.
- Dec. 11—The Universal Victoreen, by Ralph G. Hurd. Some Common Fallacies, by J. E. Anderson.
- Dec. 18—Selectivity on One Tube, by Edgar Spears. Eliminating Interference, by J. E. Anderson. The Victoreen Universal, by Ralph G. Hurd (Concluding Part).
- Dec. 25—A New Coupling Device, by J. E. Anderson. Functions of Eliminators, by Herman Bernard.
- Jan. 1, 1927—The 2 Tube DeLux Receiver, by Arthur H. Lynch. The Twin-Choke Amplifier, by Kenneth Harkness.
- Jan. 8—Tuning Out Powerful Locals, by J. E. Anderson. A Choice Superheterodyne, by Brunsten Brunn. The 2-Tube De-Lux Receiver, by Arthur H. Lynch (Part 2).
- Jan. 15—The DeLux Receiver, by Arthur H. Lynch (Part 3). The Simple Meter Test Circuit by Herbert E. Hayden. The Superheterodyne Modulator Analyzed, by J. E. Anderson.
- Jan. 22—The Atlantic Radiophone feat, by Lewis Rand. An Insight Into Resistors, by J. E. Anderson. A Circuit for Great Power, by Sidney Stack.
- Jan. 29—The Harkness KH-27 Receiver (Part 1), by Kenneth Harkness. Use of Biasing Resistors, by J. E. Anderson.
- Feb. 5—5-Tube, 1 Dial Set, by Capt. P. V. O'Rourke. The Harkness KH-27 (Part 2), by Kenneth Harkness. What Produces Tone Quality, by J. E. Anderson.
- Feb. 12—Phone Talk Put On Speaker, by Herbert E. Hayden. All Batteries Eliminated, by Herman Bernard. The Harkness KH-27 Receiver, by Kenneth Harkness (Part 3) conclusion.

Any copy, 15c. Any 7 copies, \$1.00. All these 31 copies for \$3.25, or start subscription with any issue. RADIO WORLD, 145 West 45th Street, New York City.

## CHAS. FRESHMAN'S HAPPY DAYS



(Underwood & Underwood)

SITTING IN the quiet of his study, Charles Freshman, manufacturer of radio receivers, speakers and eliminators, reaps keen delight in tuning in distant stations on his latest and most successful set, the Freshman six-tube single dial model. With business every way satisfactory; with volume exceeding even fondest hopes (both in sales and in reception), what more could a man ask?

### Station Will Test Out Underground Aerial

In cooperation with the inventor of underground radio, Prof. James Harris Rogers, WRNY will shortly go on the air with a buried antenna. As soon as the

weather permits, a huge terra cotta pipe, through which the transmitting aerial will be drawn, will be buried about six feet below the ground at Coytesville, N. J. This is the first time a broadcasting station has used this type of antenna system.

**AEROVOX** Fixed Condensers and Resistances  
 "Built Better"  
 AEROVOX Products are used by more than 300 manufacturers of Radio Receivers and "A" Eliminators.  
**AEROVOX WIRELESS CORP.**  
 60-72 Washington St., Brooklyn, N.Y.

FOR ONLY 15 CENTS get full directions how to build the Bernard. Radio World, 145 W. 45 St., N. Y. C.

### COMPLETE DATA ON THE KH-27 RECEIVER AN EXCELLENT 6-TUBE SET

Kenneth Harkness, prominent consulting radio engineer, known the world over for his ingenious radio receiver circuit contributions, designer of the famous Harkness Reflex and the Harkness Counterflex circuits, is the designer of a new receiver, known as the KH-27, which surpasses all of his other types, and which was described in the January 29th, February 5th and 12th issues of RADIO WORLD.

The outstanding features of this remarkable set are:

- (1)—Simplicity in tuning.
- (2)—Tremendous volume on locals and distant stations with tonal quality that enchants.
- (3)—No disagreeable squeals, or howls.
- (4)—Inexpensive to build.
- (5)—Works from either batteries or eliminators.

In the January 29 issue, a general discussion of the receiver, together with wonderful photos and circuit diagram were given.

In the February 5 issue, detailed assembly and wiring directions were given, accompanied with specially drawn diagrams, simplifying the wiring.

In the February 12 issue, directions on installing and operating this set were given; also Lucid diagrams accompanied this article.

Send 15c for any one copy, or 30c for all three. Send \$6 for one year's subscription (52 numbers) and get the three numbers FREE.

**RADIO WORLD**  
 145 West 45th St., New York City

### World "A" Power Unit--\$12.75

Automatically provides even, unvarying "A" current from your light socket. Absolutely noiseless. Assures full tone quality from your set and wider D. X. range. Famous WORLD quality—at less than half the cost of any similar equipment. Shipped complete, subject to inspection on receipt of price, or C.O.D. if you wish. 25 amp. unit for sets of 4 tubes or less, \$12.75. 60 Amp. unit for sets of 5 tubes or more, \$15.75. 5% discount if cash in full is sent with order. Send order today. World Battery Co., 1219 So. Wabash Ave., Dept. 82, Chicago, Ill.

**J. E. Anderson's**  
**Vacuum Tube Voltmeter**  
 Price Completely Assembled ..... \$5.00  
**M. LERNER**  
 145 West 45th Street, N. Y. City

### Radio Mailing Lists

27428—Radio Dealers, Retail, Per M.....	\$7.00
2660—Radio Mfrs., Per List.....	20.00
2857—Radio Jobbers, Per List.....	22.00
1847—Radio Jobbers, rated \$5,000 and up, Per List.....	15.00
1060—Radio Mfrs. Complete Sets, Per List.....	10.00

and any other Radio List you want. Ask for detailed price lists all guaranteed 98% correct.

**Trade Circular Co., Inc.**  
 166 W. Adams Street Chicago

### HOW THE TRANS-OCEAN PHONE WORKS

Described in detail by a famous engineer in the issue of Jan. 22, 1927 and in such a way that even the novice gets an insight into the fundamentals of this type of radio transmission. Follow this up with a description on how to build a set to listen-in on the overseas phone, by Capt. Peter V. O'Rourke, in the issue of Jan. 29, 1927. Send 30c for both of these, or better still send \$6 for one year's subscription to Radio World and get these copies as a premium. RADIO WORLD, 145 W. 45th St., N. Y. C.



## AT YOUR SERVICE

[This department is conducted by Robert L. Eichberg, director of the Extension Division of the Federated Radio Trade School, 4464 Cass Ave., Detroit, Mich. All questions regarding the construction, repair, selling, merchandising and advertising of radio apparatus should be sent direct to Mr.

Eichberg at that address, where they will be promptly answered. The answers to questions of general interest will be printed here. All others will be answered by a personal letter from Mr. Eichberg. By a special arrangement RADIO WORLD is able to offer this service free to all readers.]

## Regulations Concerning Aerials

WHEN making your radio installation be sure that you are not violating the National Fire Underwriters' Code. It is very easy for one who is unfamiliar with this set of regulations to make an installation that will seriously interfere with any attempt to collect insurance should fire occur in the house.

There are several points which should be closely watched in installing an antenna and ground system. There is no room here to quote all the provisions of the code, but a few of the high spots which are only too often neglected, may be given for your information. Incidentally, if the antenna system is installed as specified in the code, you will have an extremely efficient aerial, and better reception from your radio set can be had if the points outlined in the code are embodied in the installation.

The first important recommendation is that antenna or counterpoise outside of the building must be kept well away from

electric light, power wires, or any circuit giving more than 600 volts, and from railway, trolley or feeder wires, to avoid possibility of accidental contact between them. Any splicing or joints in the antenna system must either be soldered or made by means of an approved splicing device. If light or power circuits are used as antennas, some approved device must be used for connection. Lead-in wires and ground wires must be of copper clad steel or other metal which will not corrode to any extent. They must be of No. 14 wire or larger, unless bronze or copper clad steel is used, in which case they may be No. 17. The lead-in enters the building through some bushing or other approved device, which is fire-proof and moisture-proof and must slant up at the inner end. A lightning arrester that is approved by the Underwriters must be used. This may be located either inside—or outside of the

(Continued on page 26)

## KROBLAK

WIRE WOUND RESISTANCES

Endorsed by	STOCK SIZES	
	10 Watt Capacity	500 Ohms List \$1.00
Silver-Marshall	1,000 "	" "
THORDARSON	1,500 "	" "
STERLING CO.	2,000 "	" "
Bremer-Tully	2,500 "	" "
MAYOLIAN	3,000 "	" "
AMERICAN	3,500 "	" "
ELECTRIC CO.	7,500 "	" "
WEBSTER	8,000 "	" "
DONGAN	10,000 "	" "
	12,000 "	" "
	25,000 "	1.25
	50,000 "	1.50

M-210 Kit for Thordarson R-210, \$4.50  
M-171 Kit for Thordarson R-171, \$2.00  
For 20 Watt Type Add 50c to Above Prices

Write for Ohmage List  
Exclusive Sales Distributors

**TILSON & TILSON**  
154 Nassau Street, N. Y. C. Beekman 1575

### All Popular Kits in Stock

POWERTONE WAVE TRAP (STATION SEPARATOR) ..... \$2.00  
BRUNO BOOK OF HOOKUPS... \$0.25

Write for 50-Page Catalog

**B. C. L. Radio Service Co., Inc.**  
221 Fulton St. (R.W.) N. Y. C.

remember the name!



There MUST be something better about "CeCo" Tubes to receive the approval of such radio authorities as Browning, Lynch, Cockaday, King, Bernard and many others.

Insist on CeCo—"the tubes of longer life." There's a type for every radio need.

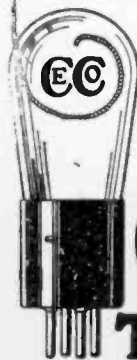

**C. E. Mfg. Co.,**  
INC.

Providence, R. I.

**CeCo**  
**TUBES**

## How to Build THE DIAMOND

5-Tube Model

Herman Bernard, designer of this wonder circuit, has written an illustrated booklet on "How to Build RADIO WORLD'S Improved Diamond of the Air." Send 50c and get this booklet, including a full-sized wiring blueprint and free namepiece.

Outstanding Features of Set: (1) Fans, charmed by tone quality, sensitivity and selectivity, report speaker reception of far-distant stations with great volume. (2) A 2-tube earphone set, a 5-tube speaker set, and a separate 3-stage audio-amplifier for immediate use with any tuner, are combined in one. (3) No rheostats are used. (4) The set is inexpensive to construct and maintain. (5) The set works from outdoor aerial or loop; hence no aerial problems present themselves, in city or country. Send \$6 for year's subscription and get booklet, blueprint.

[Newsdealers or radio dealers, order the booklets with blueprints included, in quantity, direct from American News Co. or branches.]

**RADIO WORLD**  
145 West 45th St., New York City

Next  
Public Offering  
of

**Bernard**  
**RADIO STOCK**

\$12.50 per share

There remains a limited number of shares which may be had at

\$10.00 per share

if purchased immediately, this being the last offering at that price.

The instantaneous success made by the Bernard Bronze Beauty radio with the public and the constantly increasing orders for this machine have far exceeded our expectations.

Therefore, it will only be necessary to offer a limited amount of stock at the new price of \$12.50 in order to fully cover our financial needs for increasing our manufacturing capacity.

The radio shares of present-day successful producing companies are recognized by the foremost financial authorities as excellent investments.

Although the Bernard Radio Corporation is a new company, the way in which its product has met with public favor makes the shares of this company an excellent investment around present prices with splendid speculative opportunities for big increase in value in the near future.

Sign and detach Coupon for further information

**CHAS. J. SWAN & CO.,**  
51 East 42nd Street, New York City.

Kindly reserve for my account, subject to cancellation if dissatisfied upon receipt of further information, ..... shares of Bernard Radio Corporation stock at \$10.00 per share. Send at once complete information without obligating me in any way.

NAME .....  
ADDRESS .....  
CITY and STATE .....

(Continued from page 25)

building, but should be kept away from materials that will burn easily, such as window curtains, and should be close to the place where the lead-in enters the house. A ground clamp must be used to make connection to the ground wire. A ground to a cold water pipe is recommended. The use of a gas pipe for a ground is prohibited.

You will notice that all of these provisions are based upon good, sound sense, and that if they are followed, not only will the building be absolutely protected, but the antenna circuit will have the main points which make for efficiency. That is, good ground, and good electrical joints in the antenna circuit.

It will be well to look over your aerial and see that the points outlined here are complied with. Further information may be had upon request.

\* \* \*

RECEIVED YOUR reply to my letter and have wired my set up for the power tube and it works fine. I get the clear undistorted volume which I never had.

Now I have something else to ask you. I wish to make a permanent magnet and want to know if it can be made from tool steel. Of course, it would have to be shaped and drilled before it was hardened. Now if that kind of steel can be used, how should it be hardened and also magnetized?

I'll tell you the reason for asking you this question. Most anything I put my hands on I can finish, and I am on a test that I can make a speaker unit. The coil and balanced armature portion come easy,

but I am stuck on the magnet and of course the test requires that I construct the unit from start to finish so that is why I am asking you for his information.

—W. LINCOLN.

Shape your piece of steel as you wish, then heat it to a cherry red and plunge it into cold water to temper it. You will have to magnetize it by winding a coil of fairly heavy insulated wire around it and passing a strong current through the wire for a few minutes. I believe that this will enable you to make the horseshoe magnet quite successfully, but it probably will not be as strong as those in commercial speakers. I would suggest that you try magnetizing with a Ford magneto magnet.

\* \* \*

I HAVE a Victoreen Universal Super-Heterodyne with one dial, with a compensator of 20 degrees variation in the first condenser.

I have a Bodine DeLuxe loop which was marked .0005 on the box and which I was told would be the proper loop. On wave-lengths above 350 meters, the results are good, but the compensator has to be turned back, that is 20 degrees less the capacity on the condenser across the loop. And below 350 meters I cannot pick up a thing on the loop.

On a small antenna I can get almost anything on the whole broadcasting band without using the compensator at all. I have the batteries in the basement, using about 20 foot leads on both batteries. The set works just fine on an antenna, as I have picked up Haiti, Havana, etc., but the loop does not operate satisfactorily. I would appreciate any information on this trouble.—SYDNEY NORDGRIN.

I suppose you understand that there are certain changes that must be made in your set to make it work satisfactorily on a loop. You cannot connect it in parallel with the antenna coil. It must be directly across the variable condenser, with the antenna coil disconnected. If

your set is correctly wired for the loop, then it seems the loop has a greater number of turns than required.

\* \* \*

I AM availing myself of the service offered by RADIO WORLD, and would appreciate it very much if you would be kind enough to assist me in a few things. I have built quite a number of different type sets and have had very good results from all of them. I now have a six-tube radio frequency set consisting of two stages of radio frequency, one detector, and three stages transformer audio. I can get almost any time, under fair conditions, fifty-one stations on the loud speaker, on the second stage of amplification. When I plug in on the last stage, there is a terrible whistling that I have tried to eliminate and cannot. When I put my hand near the detector, it becomes so loud I have to shut it off. Accompanying this whistling is a steady low pitch bubbling sound, that I can control by turning down my rheostat, but it has no effect upon the whistle. When using the second stage I still have this bubbling to a lesser extent, but it does not interfere to any great extent. If a trolley is coming, I can hear it five minutes before it reaches the house and sometimes it takes the reception away entirely. Is there no remedy for this continued interference from the trolley line? I have tried various grounds, changed the direction of my aerial and many other things. If you can give me any information on this subject, I shall greatly appreciate it.—NEWTON L. WOOD.

Sets with three stages of audio frequency amplification should use 2-to-1 ratio transformers. To eliminate the whistle and still have three stages of amplification you might use resistance coupling for the second stage instead of the transformer. In regard to the interference of the trolley cars, communicate with the trolley car company. It may be that they have some defective apparatus. If they are unwilling or unable to do anything in this connection, I believe there is nothing you can do to stop the noise.

\* \* \*

I AM a new radio fan and have just purchased a four-tube Atwater Kent. I am not very familiar with radios so I am coming to you for some advice. Why is it that when the local broadcasting station

Concluded on page 27)

Alden Processed  
**NA-ALD**  
Sockets and Dials

UX POWER TUBES installed in any set without rewiring by Na-Ald Adapters and Connectors. For full information write Alden Manufacturing Co., Dept. S-20, Springfield, Mass.

**LYNCH**  
**METALLIZED**  
**LYNCH**  
**FIXED RESISTOR**

**HARD RUBBER**

SHEET—ROD—TUBING  
Special Hard Rubber Parts Made to Order  
**RADION and HARD RUBBER**  
PANELS, ANY SIZE

Send for Price List

WHOLESALE RETAIL  
NEW YORK HARD RUBBER TURNING CO.  
212 Centre Street New York

## WHAT CIRCUIT DO YOU WANT?

DUE TO THE GREAT DEMANDS FROM OUR READERS FOR VARIOUS BACK NUMBERS OF RADIO WORLD, OUR STOCK OF THESE HAS BEEN RUNNING LOW RECENTLY. OUR EDITORIAL STAFF IS AT PRESENT GATHERING DATA AS TO WHICH CIRCUITS THERE IS MOST DEMAND FOR AND THESE WILL BE REPUBLISHED IN COMING ISSUES OF RADIO WORLD. THERE ARE MANY RECENT EXPERIMENTERS WHO WOULD LIKE TO PROBE THE POSSIBILITIES OF THE OLDER CIRCUITS, BUT WHO CANNOT OBTAIN THE NECESSARY INFORMATION. LET US HEAR FROM OUR READERS AS TO WHICH CIRCUITS THEY WOULD LIKE TO SEE PUBLISHED AGAIN. IN WRITING US PLEASE MENTION ONLY THE CIRCUITS WHICH HAVE APPEARED IN RADIO WORLD.

TO INSURE YOUR GETTING ALL OF THIS INFORMATION, SEND IN YOUR SUBSCRIPTION NOW FOR ONE YEAR AT \$6.00. THIS WILL ENTITLE YOU AS A PREMIUM TO MEMBERSHIP IN THE RADIO UNIVERSITY THROUGH WHICH YOU WILL GET ALL YOUR RADIO QUESTIONS ANSWERED FREE DURING THE PERIOD COVERED BY SUBSCRIPTION. OR IF YOU PREFER ANOTHER RADIO PUBLICATION, AS A PREMIUM, TURN TO ANOTHER PAGE IN THIS ISSUE WHERE YOU CAN CONSULT OUR PREMIUM SUBSCRIPTION OFFER AND MAKE YOUR CHOICE OF THE OTHER PUBLICATION. IN SUBSCRIBING FOR ONE YEAR YOU ARE ENTITLED TO ANY SINGLE ONE OF THESE PREMIUMS. SUBSCRIPTION DEPARTMENT, RADIO WORLD, 145 W. 45TH ST., N. Y. C.

ANY SET DESCRIBED IN  
**RADIO WORLD**

BUILT TO YOUR ORDER. WRITE

**M. LERNER**

1498 Remsen Ave. Brooklyn, N. Y.

## HOW TO BUILD THAT CIRCUIT

The following circuits have been explained and illustrated in back issues of Radio World:

The National Power Amplifier, Dec. 25, Jan. 8, 15, 22, 1927. 4 copies 60c.

The Bernard, Oct. 16, 23, 1926. 2 copies 30c.

The Antennaless Receiver, Nov. 27, Dec. 4, 1926. 2 copies, 30c.

The Regenerative Equamatic, Dec. 4, 1926. 15c per copy.

The Equamatic, Oct. 2, 9, 16, 23, 1926. 4 copies, 60c.

The Lincoln Super-Heterodyne, Dec. 4, 1926. 15c per copy.

The 3-Tube Karas, Dec. 11 and 18, 1926. 2 copies, 30c.

The Lynch Amplifier, Jan. 1, 8, 15 and 22, 1926. 4 copies, 60c.

Or send \$6.00 for yearly subscription and get as a premium any one set of circuit copies noted above. No other premium with this offer.

**RADIO WORLD**

145 WEST 45th STREET, N. Y. C.

*Concluded from page 26)*

is on the air it spreads all over my dials? I am not getting the volume or distance that would be expected from such a set. Can you tell me what is wrong? I am using a 6-volt A storage battery, two 45-wet B batteries, and four 201A tubes. My connections are right, according to the diagram received with the set. Can you tell me how to increase distance and volume at very little cost? What in your opinion is the best B eliminator on the market? Are they better than B batteries?—JOHN BEVELUDGE.

You might be able to make your set more selective by putting a .00025 mfd. fixed condenser in the antenna lead. This should sharpen tuning to a considerable degree. It is also possible that you are using too long an aerial. Refer to your instruction book and remember that the term aerial is generally used to include the lead in and the ground.

I cannot recommend any B eliminator as being "best" because there are so many good one. Depends on nature of set.

CAN a five-tube Freed-Eisman receiver be changed from the Neurodyne to a TRF type without tearing down the set? If so, will you advise me by sending picture diagram. Is there some balancing instruments which would be of better service than the sliding tube used in Freed-Eisman sets?—S. OVERTON.

The Neurodyne is a form of tuned radio frequency receiver, so I do not see that any changes will be necessary in your Freed-Eisman set. The sliding tube which you refer to is a neutralizing condenser, and if properly adjusted will be perfectly satisfactory. It may be that your neurodyne is out of adjustment. If so, either re-neutralize it yourself, or send it back to the dealer from whom you bought it.

HAVING BEEN a reader of RADIO WORLD for some time and noticing you have given information to a number of those inquiring, I wonder if you could not help me with some of my trouble.

In my Super-Heterodyne using New York Coil Co. parts, e.g., coupler and intermediate transformers I have been bothered with a harmonic or what seems to me a double oscillation that should not be in my set.

**Prevent the Reception of One or Two Stations**



BY USING A  
**Powertone Wave Trap**  
(STATION SEPARATOR)  
**Price \$2.00**  
at all good dealers.  
Dealers and Jobbers Write  
**Powertone Elec. Co.**  
221 Fulton St.  
New York City

**BLUEPRINTS**

for  
**Radio World's 4-Tube Universal Receiver**

Front Panel and Wiring of the Set **\$1.00**  
Exactly as specified by Herman Bernard  
**RADIO WORLD**  
145 W. 45th St. N. Y. City

That is, on KMA at 461 meters which comes in at 61 on the oscillator dial, it weakens a little and then comes in again at 65. Again take KOIL at 305. It comes in at 27 then again at 30, or at 2nd Harmonic at 59 then again at 64. I can hear them all the way between unless I turn the potentiometer very close to the oscillating point, then it forces it sharper at 59 and 64. Now what is the trouble, and what might I do, to correct same?

I have tried a number of hookups and different ways of mounting parts with the same results. If you are not acquainted with these transformers they are air core with a Bakelite shell covering. At present I have them mounted 8 in line with the coupler and transformers mounted underneath. Sockets are about 1/2 inch apart.

I have about come to the conclusion that the trouble is in the transformers and wonder if shielding each transformer or all of them from the rest of set would be of any benefit?—G. H. Y.

The fact that stations come in at two points on the dial does not necessarily indicate trouble in a Super-Heterodyne. This is because the frequencies generated by the oscillator may be either higher or lower than that of the incoming wave. Therefore, a heterodyning note will be produced on two separate frequencies.

The set will operate best, of course, when the potentiometer is near the oscillating point. This is a natural condition also because all circuits are most efficient when just under oscillation.

Shielding may be of help to you, but I doubt if it will clear up the troubles you mention. Should you wish to try shielding, use copper cans for best results. Each can should be grounded and not touch the coils.

**VICTOREEN Super Coils**  
Send for Folder  
**Geo. W. Walker Co.**  
6328 Carnegie Ave.  
Dept. B Cleveland, O.

**New Bretwood Leak Is Straight Line "R"**

The North American Bretwood Company recently released for distribution in the United States, Canada, Cuba and Mexico, the new improved De Luxe Model Bretwood Variable Grid Leak. This leak is made in England and imported to the Western Hemisphere by the North American Bretwood Company, under an exclusive franchise.

The improvement in the leak consists principally of a syphon container which distributes a constant supply of the resistance element and makes the readings truly "straight line resistance". For instance, the new resistance range is 50,000 to 10,000,000 ohms (.05 to 10 meg.) and the knob is turned twelve times from maximum to minimum setting. Each full turn therefore represents one-twelfth of 9,950,000 ohms. In other words, the knob rotation is proportional to the resistance thereby cut in. The difficulty of uneven distribution of resistance has been overcome. Also, steadiness of resistance change avoids the "jumping" characteristics, whereby small knob variations produce large resistance changes, or large variations small changes.

The De Luxe Model Bretwood is supplied either with or without the .00025 mfd. bullet grid condenser attached.

The single hole panel mount feature is retained, and in addition a base is provided so that, if preferred, the leak may be baseboard mounted.

In a RADIO WORLD's Universal 4-tube receiver the De Luxe Model Bretwood Variable Grid Leak, with condenser attached, is prescribed by Herman Bernard in the official list of parts.

**From A to Z.**  
Practically every well known B eliminator manufacturer recommends or uses CLAROSTAT wherever a variable resistance is specified.  
"The GATEWAY TO BETTER RADIO," 32 pages covering the latest angles in radio. Send 25c to Dept. R.W., American Mechanical Labs., Inc., 285 N. 6th St., B'klyn.

**POSITIVE ELIMINATION OF INTERFERENCE "WEB" WAVE-TRAP**  
**PRICE \$2.00**  
Positively eliminates interference. Increases Distance. Increases Volume. Increases Selectivity. Reduces Static. Works on all sets, including loop sets.  
Tested and Approved by RADIO WORLD Laboratories  
ON SALE AT YOUR DEALERS, or will be sent upon receipt of check, money order or cash by the manufacturer, under money back guarantee.  
Manufactured by  
**WALTER E. BATHGATE CO., Inc., 65 West Broadway, N. Y.**

**FILL OUT AND MAIL NOW**  
**SUBSCRIPTION BLANK**

**RADIO WORLD**

RADIO WORLD

145 West 45th Street, New York City  
(Just East of Broadway)

Please send me RADIO WORLD for ..... months, for which please find enclosed.....

**SUBSCRIPTION RATES:**

Single Copy .....	\$ .15	.....
Three Months .....	1.50	.....
Six Months .....	3.00	.....
One Year, 52 Issues .....	6.00	.....
Add \$1.00 a Year for Foreign Postage; 50c for Canadian Postage.		.....



# The New Universal Four-Tube Receiver

(Concluded from page 9)

Wire the filament leads first. Get a piece of wire, connect the plus posts of the sockets and join this to the cable lead which you will use for a A plus. A minus is wired by connecting the A minus cable lead to one side of the switch, S1, and to one side each of the two audio Amperites and to one side of the rheostat, R2, and to the ground post on the strip at rear. Connect A minus to left-hand bracket. The other side of the rheostat goes to one side of the Amperite R1, at left. Then the connections are completed to the F minus socket posts. The open side of R1 goes to the F minus of sockets 1 and socket 2, while the open side of R3 goes to F minus of socket 3 and the open side of R4 to the F minus of

socket 4. The pilot light is wired by running the output lead of the switch, S1, to the base of the pilot light socket, while the upper lug of the socket is connected to A plus. A flexible lead may be used on the A plus connection from the nearest socket.

The antenna post is connected to the rotary plates of C4 and to the lower end of the primary L1, which on a General Radio coil would be at left and rear. The ground post is connected to the end of the primary, L1, and soldered to the left-hand bracket, as explained. This, of course, enables the left-hand bracket to be used at any time as the A minus lead. In fact, in wiring the rheostat a short jumper from the bracket will serve the purpose nicely. The right-hand bracket need not be grounded.

### Connecting the Midtap

The other side of the condenser, C4, which is on the left rear of the base-board, is connected to the plate of tube 1. This is the P post of socket 1. The beginning of the secondary which adjoins the end of the primary, is connected to the rotor plates of C1, while the other secondary terminal goes to the stator plates of C1. The midtap is connected by a stiff insulated lead to the F minus post of the first audio transformer. The insulation is scraped off about midway and the cable lead is soldered to the bare part and this lead is marked C minus 3.

The beginning of the primary L3 is connected to the plate of tube 1 and the end of the primary goes to B plus 90. This is to be run about 1/2-inch back from

the socket and then to the right and turned forward to come up to meet the upper lug at left of the General Radio coil. The lower lug, which represents the end of the primary, is soldered to one of the leads of the cable which is now B plus 90. The secondary L4 is wired with beginning of the coil going to the rotor plates of C2 and the end of the coil to the stator plates and to one side of the Bretwood Variable Grid Leak and to one side of the Bretwood bullet condenser, C3. The other side of this combination goes to the grid post of the detector socket 2.

In connecting the leak, see that the lower lug on which the condenser rests, goes to the grid post of the socket, and the upper lug is connected to the open end of the grid condenser and to the stator plates of C3. The plate of the detector tube is connected to the rotor plates of C5 and the stator plates of C5 go to the rotor of C2, i. e., the end of L4.

### Wiring Completed

If the Electrad single closed jack is wired with the lug nearest the strip being to left, then the other lug should be bent forward a little bit and connected to the P post of the first audio transformer. The left-hand lug then goes to the B plus post of this transformer and to the B plus cable leads. The plate of the detector socket is connected to the U-shaped prong of the jack. Previous connection from the plate was made to the regeneration condenser C5, it will be remembered. G of the first audio transformer goes to the G post of socket 3. F minus of AFT1, has already been connected. P of socket 3 goes to P on AF2. B has been previously connected. G of AF2 goes to grid of socket 4 while F minus of AF2 goes to another C minus cable lead, which will receive 9 volts. It is well to put numerical tags on the C minus leads. The plate of the last tube goes to the hooked spring of the single open jack. This is the lug farthest from the strip on which it is mounted. The other lug goes to cable lead B plus power, e.g., 135 volts. Connect A minus and B minus at batteries. This completes the wiring.

### N. B. C. NATION-WIDE SERVICE

"Today the National Broadcasting Company, in co-operation with the associated stations that comprise its networks, can insure the facilities for a truly nation-wide service of broadcasting. The fact has been demonstrated on a number of outstanding occasions during recent months, when the voices of President Coolidge and other notable speakers have been transmitted to the entire nation by a system of stations interconnected by wire from coast to coast," said M. H. Aylesworth, President of the N. B. C. in a recent address.

## RADIO WORLD'S QUICK-ACTION CLASSIFIED ADS

10 CENTS A WORD  
10 WORDS MINIMUM  
CASH WITH ORDER

**INTRODUCTORY OFFER:** \$5.00 genuine Earl Trickle Charger mailed postpaid upon receipt of \$3.00. Fully guaranteed. National Import Company, 413 Insurance Building, Washington, D. C.

**DISTRIBUTORS, DEMONSTRATORS** — Sell Long Life quick patches. Self-Vulcanising. Over 200% profit. Steady repeater. Long Life Patch Co., 1293 West 114th Street, Cleveland, Ohio.

**THE BURGE**—Equity 8 to 14 Tubers, 44 Stations one evening. Will play set for set with any Radio in the U. S. Get prices on parts necessary. C. C. Burge, "Assembler of Larger Radio," 340 So. Turner Ave., Chicago, Ill.

**RADIO MECHANICS**—Get our new plan—make hundred dollars weekly. Send fifty cents stamps for complete plans. Radio Service Bureau, 513 Burns-Gray Bldg., Detroit, Mich.

**DEALERS**, five-tube receiver, \$16.50. Write Parson Radio Co., 432 Tompkins Ave., Brooklyn, N. Y.

**ONLY \$25.00**, beautiful and wonderfully constructed five tube receivers; best parts only used. Panel 7 x 18 in. Other specialties. Send for pamphlets. L. W. GOODMAN, Drexel Hill, Penna.

**PATENTS**—Write for free Guide Books and "Record of Invention Blank" before disclosing inventions. Send model or sketch of your invention for our Inspection and Instructions Free. Terms reasonable. Radio, Chemical, Mechanical, Electrical and Trademark experts. Victor J. Evans Co., 924 Ninth, Washington, D. C.

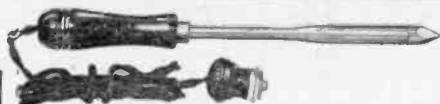

The Federal Iron is the most used electric iron used today endorsed by the leading Radio engineers and manufacturers. Guaranteed to give Satisfaction, and sold direct to user for less money. The Standard Iron prepaid to you...\$1.85 Our Junior Size prepaid to you...\$ .95 Federal Sales Box 14 Fostoria, Ohio

### Why is the Karas Equamatic the Most Efficient Receiver Ever Designed?

Write us for Full Information

**KARAS ELECTRIC CO.**

1148 Association Bldg. Chicago, Ill.

## SPECIAL PREMIUM SUBSCRIPTION OFFER

### For NEW RADIO WORLD Subscribers Ordering NOW

Radio World has made arrangements

—To offer a year's subscription for any one of the following publications with one year's subscription for RADIO WORLD

- RADIO NEWS or
- POPULAR RADIO or
- SCIENCE AND INVENTION or
- BOYS' LIFE or
- RADIO DEALER or
- RADIO (San Francisco) or
- RADIO AGE.

This is the way to get two publications

- for the price of one:
- Send \$6.00 today for RADIO WORLD
- for one year (regular price
- for 52 numbers)
- and select any one of the other nine publications for twelve months.
- Add \$1.00 a year extra for
- Canadian or Foreign Postage.
- Present RADIO WORLD subscribers
- can take advantage of this offer by
- extending subscriptions one year
- if they send renewals NOW!

### RADIO WORLD'S SPECIAL TWO-FOR-PRICE-OF-ONE SUBSCRIPTION BLANK

RADIO WORLD, 145 West 45th Street, New York City.

Enclosed find \$6.00 for which send me RADIO WORLD for twelve months (52 numbers, beginning..... and also without additional cost, Popular Radio, or Radio News, or Science and Invention, or Radio Dealer, or Radio (San Francisco), or Radio Age, or Boys' Life (or \$10.00 for two yearly subscriptions). No other premium with this offer.

Indicate if renewal.

Offer Good Until

April 21, 1927

Name .....

Street Address .....

City and State.....



## Literature Wanted

THE names of readers of RADIO WORLD who desire literature on parts and sets from radio manufacturers, jobbers and dealers are published in RADIO WORLD on request of the reader. The blank below may be used, or a post card or letter will do instead.

RADIO WORLD,  
145 West 45th St., N. Y. City.

I desire to receive radio literature

Name .....  
Address .....  
City or town .....  
State .....

Herbert S. Thurston, 100 School St., Everett, Mass.

H. J. Elmendorf, 904 Allison St., Seattle, Wash.  
R. B. Southworth, 4673 Lakeside Ave., South Seattle, Wash.

Nesbit Radio Shop, 1710 Sass St., Erie, Pa.  
Frank Goodrich, 222 West St., Wilmington, Del.  
Philip Paustenbach, 1105 Montana Ave., Tarentum, Pa.

B. W. Gresham, Box 552, Richmond, Va.  
F. L. Robbins, Millville, Pa.  
R. Herwig, 371 State St., Brooklyn, N. Y.  
Lawrence Le Micux, R. R. No. 3, Byron Center, Mich.

I. Beaudoin, 566 William David St., Maissonneuve, Montreal, Province of Quebec, Canada.  
A. L. Naancy, 2809 North Guad St., Austin, Tex.  
Paul A. Ibiseman, 1025 Lakewood, Youngstown, Ohio.

Scott Jackson, Arkansas Pass, Tex.  
George Butts, Arkansas Pass, Tex.  
Radio Service, P. O. Box 1122, Ft. Worth, Tex.  
R. E. Lacke, 910 Prospect Place, Brooklyn, N. Y.

Ray L. Cover, 232 Market St., Highspire, Pa.  
Mrs. E. Woodsan, Box 592, Rocky Mount, N. C.  
Heron's Radio Shoppe, 165 Jessie St., San Francisco, Calif.

J. P. McCormick, 180 Norman Ave., Brooklyn, N. Y.  
Peter Bello, 619 14th St., Union City, N. J.  
B. Seanon, Box 23, Wicasset, Me.  
Lawrence Levin, 19 East Main St., Port Jarvis, N. Y.

Walter H. Ostrander, 78 Oak St., Kingston, N. Y.  
C. Russ Martz, 513 East 4th St., Berwick, Pa.  
John Graham, 802 Upland St., Chester, Pa.  
William B. Orr, Clayton, N. J.

H. K. Peterson, 37 Washington, Dansville, N. Y.  
J. M. Hoyt, 83 Lyman St., Brockport, N. Y.  
Elmer E. Laughlin, 1393 Fulton St., Brooklyn, N. Y.

COMPLETE DATA on "How to Build a DC A and B Eliminator," were given in the Dec. 4 issue of RADIO WORLD, by Lewis Winner. Lucid photos and diagrams accompanied this excellent article. Either send 15c for this copy, or begin your subscription with this issue. RADIO WORLD, 145 West 45th St., N. Y. City, N. Y.

## EASY CLEANING

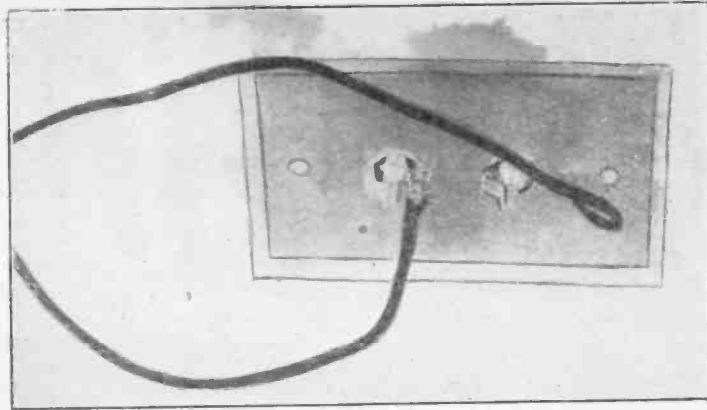

(Hayden)

A NEW DEVICE, containing a pair of phone tip jacks, mounted on a plate, which is installed in back of a console for connection of antenna and ground wires, has just appeared on the market. Tips are connected to the antenna and ground outside the set, while the tip jacks go to the respective posts inside the set. This device proves very helpful to the maid, for when she is cleaning she disconnects aerial and ground simply by pulling 'em out.

## HOW CURRENT FLOWS

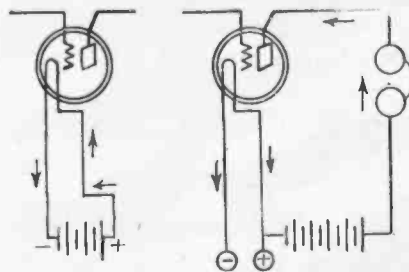

THE direction and effect of current flow are very interesting. Outside the battery the flow is from plus to minus, but inside it is from minus to plus. This subject will be discussed in detail in an early issue of Radio World.

## INSURE YOUR SET

Identify all your leads instantly. Avoid losses. No more short circuits. Quick hookup. Includes Power Tubes and all "C" voltages. Blan's Battery Markers, send now for set of 15, with free log book and station map.

**10c**

## The "WEB" WAVE TRAP

The finest, smoothest appliance of its kind for the elimination of interference.

**\$2.00**

Blan, the RADIO MAN  
145 East 42nd Street New York City

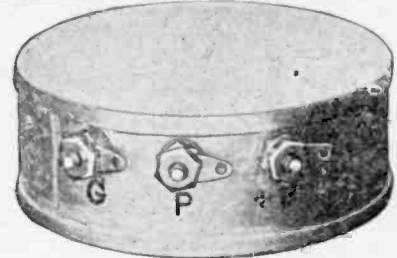

## SICKLES

Shielded Tuned Radio Transformer  
The ideal coil for the Na-ald Localized Control Tuning Unit, and for Truphonic Catacomb Assembly. Widely adaptable to all leading control units. This transformer is compact, sturdy, sharp-tuning. Prevents both outside and local interference.

PRICE \$2.00

Send for catalog

OTHER SICKLES

No.	Coil	Prices
24.	Browning-Drake	\$7.50 Set
18A.	Roberts Circuit	8.00 Set
25.	Aristocrat Circuit	8.00 Set

## THE F. W. SICKLES CO.

142 UNION STREET  
SPRINGFIELD MASS.

# By ARTHUR H. LYNCH

## A Series of Five Important Articles on HOW TO USE THE DE LUXE SYSTEM

This series tells how to build the 2-tube De Luxe Receiver (without audio) and how to adopt this or any other set so as to obtain the necessary power from the AC electric lamp socket.

Mr. Lynch is one of America's leading radio authors and designers. He has done the best job of his life in this comprehensively illustrated series, a digest of which follows:

Dec 25 Issue—Theoretical and historical discussion of the De Luxe Receiver and the audio channel and B eliminator. Jan. 1—The 2-tube set fully described and illustrated, including wiring and choice of tubes. Jan. 8—The National Lynch Power Amplifier and B Supply (3-stage AF and B and C eliminator, adaptable to any receiver). Many illustrations include picture diagram of wired connections to photo-graphed parts. Jan. 15 and 22—De Luxe reception from lamp socket with latest devices, including trickle chargers and A battery, relay, trickle charger and Abox filter, with picture diagrams of wiring, from antenna to the Acme speaker.

Send 15c for any one copy, or 60c for all five.  
Send \$6 for one year's subscription (52 numbers) and get the five copies FREE!

RADIO WORLD 145 WEST 45th ST. NEW YORK



Court Commercial Photo, Hempstead, L. I.  
ARTHUR H. LYNCH, auto speed demon and radio enterpriser extraordinary, about to take a 60-mile-an-hour jog in his car.

# BST 5

Tested, Approved and Received Certificate of Merit from Radio News and Radio World

# \$40.00

## Gets 115 Stations With B. S. T.-5

Have been using one of your B. S. T.-5 sets about three months and I certainly am pleased with the results. I am using a 90 ft. aerial, B eliminator, storage battery and a cone speaker and have logged 115 stations from WOK, 217.3, to KSD, 545.1, all on loud speaker loud enough to be heard all over my house with a clear tone. My neighbors say they have heard it several times in their house with all windows closed and enjoyed it.

W. R. WESTCOTT, 128 Biddle St., Kane, Pa.

## B. S. T. Has the "Punch"

I am more than pleased with your B. S. T., for it sure has the punch to go get the stations. At present it is going "strong"—taking care of two speakers. A Western Electric in my home and one in my mother's home next door and both have real volume.

JOHN H. BARTON,

277 Delaware St., New Brunswick, N. J.

I take great pleasure in telling you that my B. S. T. 5-tube set is working splendidly in every way, and the cabinet itself is beautiful, and admired by all my friends.

THOMAS HARTLE,

155 Perry St., Paterson, N. J.

## DIRECT FROM FACTORY TO YOU SAVES HALF AND IS GUARANTEED



**IMMEDIATE  
DELIVERY**

*New model cabinet Du Pont Duco finish; base 21" long by 8" wide, height 9 1/2", top 21" by 6". Five-ply walnut veneer*

This highly sensitive, powerful and selective BST-5 radio receiver has all up-to-the-minute improvements. Heavy aluminum automobile type chassis, shielded against stray currents and distortion. Flexible grip, Universal type sockets, eliminating microphonic noises. Has provision for battery eliminator and any power tube. Fahnestock clips on sub-panel for adjusting C battery, has voltages for power tube. Efficient on either long or short aerial, including indoor aerial. This BST-5 sets a new standard for true tone values and selectivity. This BST-5 gives greater volume than many six-tube sets and consumes less current.

Shipment made same day we receive your cheque or P. O. Money Order for \$40.

*RADIO WORLD Guarantees the Responsibility of This Advertiser*

# B. S. T. CONE SPEAKER

## Guaranteed to give Satisfaction in Tone, Volume and Appearance Adjustable to Volume Desired



18 inches in diameter edged in Gold Braid, Art Metal Base can be placed on highly polished surface without danger of scratching.

**Immediate  
Delivery**

# \$7.50

**Shipped Direct  
from Factory**

*Satisfaction Guaranteed or Money Back*

**GUARANTY RADIO GOODS CO.** 145 West 45th St., New York

# Announcing—A NEW LARGE SIZE and



## A NEW LOW PRICE

Beginning with the April issue, "SPARETIME MONEY MAKING" will be increased to the large magazine size, 9x12 inches, and the subscription price reduced from \$2.50 to \$1.50.

### Bigger and Better Now—at Less Cost

#### SOME FEATURE ARTICLES FOR APRIL

- Starting People in Business by Mail, by Ross D. Breniser.
- How to Assemble the Popular Miniature Ship Models, by J. F. Clemenger.
- How to Make Money Writing for Publication, by Montanye Perry.
- Make Woolen Doll Toys from Old Socks, by Herbert E. Hayden.
- The Preparation of Butterflies for Trays, by Dr. E. Bade.

Money Making, the popular magazine of opportunities, has grown up. From the small size of 6x9 inches it has been increased to 9x12 inches—and at the same time its price has been reduced from \$2.50 to \$1.50. There will be absolutely no change in the high quality of the articles. Our special printing process enables us to give you more at a lower price. If you enjoyed Money Making before you'll get double value now. Ask your newsdealer for the new issue NOW.

**15c. THE COPY—SOLD EVERYWHERE**  
**THE CONSRAD CO., Inc.**

230 FIFTH AVENUE

NEW YORK, N. Y.

**When radio stations crowd the air and spoil your programs**      **use a wave trap**

### How to make a SIMPLE WAVE TRAP and CLARIFIER

THE NEW WAVE TRAP PATTERN      BRAND NEW CONSRAD PATTERN ENABLES YOU TO BUILD ONE AT HOME

This new pattern contains a gigantic blueprint, size 27 1/4 inches by 20 1/2 inches, containing simplified Panel layout. Front View, Top View, Side View and Picture Wiring diagram. All measurements are shown actual size. Also a complete Illustrated Pamphlet is enclosed that shows you exactly how to proceed throughout the entire construction; these are enclosed in a heavy folder envelope size 9 1/4 x 9 1/2 inches.

Note: This Wave Trap can be installed in a few seconds. It does not have to be put inside your set.

NO matter how large or small, how expensive or inexpensive a Radio Set may be, it can be decidedly improved with a good WAVE TRAP.

The Receivers of today are not built incorrectly—They are as efficient as Radio Engineering skill can make them.

The fault lies in the fact that there are so many stations on the air that receivers cannot separate them properly.

The simple WAVE TRAP solves this problem—It brings order out of Chaos. It helps separate the Wavelengths.

A WAVE TRAP does not have to be installed in your set. The New Consrad Pattern shows you how to build a simple WAVE TRAP—By building at home you save 1/3 to 1/2 the cost of a ready made instrument.

And the simplified Consrad system that has been used to construct over 500,000 home-made Receivers is understandable by a child.

Anyone with a Screwdriver, a Scissor, a Pen knife, and a few other household tools can build from a Consrad Pattern in a few nights.

The contents of the CONSRAD WAVE TRAP Pattern are shown on the left.

ORDER YOUR PATTERN NOW. BEFORE MORE PROGRAMS ARE SPOILED BY CROWDING OF STATIONS

**25c**

**COMPLETE PATTERN 25c** At All Dealers

If your dealer cannot supply you write direct

EVERYWHERE The Consrad Co., Inc., 230 Fifth Ave., New York City



# a NEW radio that "gets" everything! Six tubes ~ One control

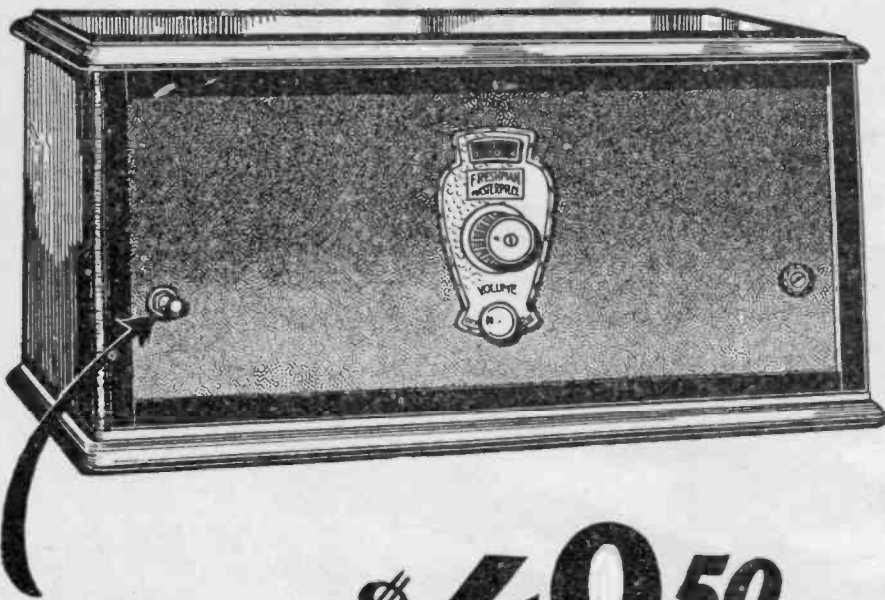

MERELY turn the dial from point to point and station after station comes in separately, clearly and distinctly. The one dial is the only tuning device on this new Freshman Radio. Its amazing power allows stations from a great

## Distance

to be tuned in right through the locals. Its superior construction and efficiency separate the different wave-lengths and tune out the undesired stations with startling

## Selectivity

allowing you to listen to exactly the station that you desire without bother or interference and with fine

## Tone Quality

which is the result of scientifically constructed audio transformers perfectly designed and co-ordinated to match this powerful radio.

### Distance

Distant stations often broadcast on exactly the same wavelength as locals. This new Freshman set is so powerful that it brings in stations from all over the country. Sometimes it is desirable to cut out the distant station broadcasting on the same wavelength as the local to which you are listening; if so, just pull out the distance switch indicated above..

**\$49.50**

# Six tubes ~ One Control FRESHMAN MASTERPIECE

**Hear it  
To-day**

At any Authorized  
FRESHMAN  
Dealers Store

**Operate it  
Yourself**

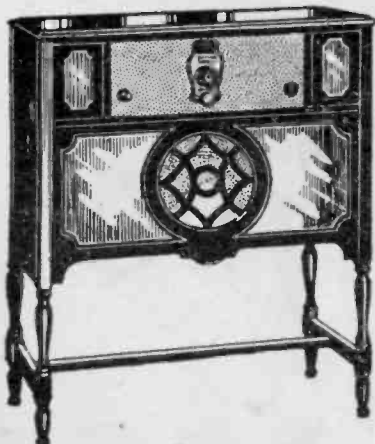

Panelled in genuine mahogany. Built-in cone speaker. Spacious battery compartment. . . . . **\$79.50**

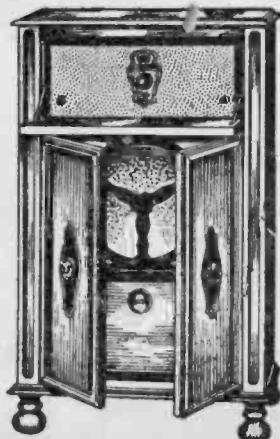

A distinctively beautiful radio panelled in genuine mahogany. Large built-in cone speaker. . . . . **\$99.50**

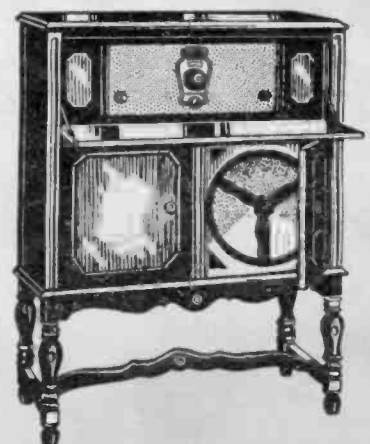

This massive console is panelled in genuine mahogany. 12-inch cone speaker. . . . . **\$109.50**

CHAS. FRESHMAN Co., Inc., 240-248 W. 40TH ST., NEW YORK CITY

# WORLD'S GREATEST RADIO